

# TRIO *pacesetter in amateur radio*

## TS830S *V.B.T., notch, IF shift, wide dynamic range*

The TS-830S has every conceivable operating feature built-in for 160-10 metres (including the three new bands). It combines a high dynamic range with variable bandwidth tuning (VBT). IF shift, and an IF notch filter, as well as very sharp filters in the 455kHz second IF. Its optional VFO-230 remote digital VFO provides five memories.

**TS-830S FEATURES:**

- LSB, USB and CW on 160-10 metres, including the new 10, 18, and 24MHz bands. Receives WWV.

- Wide receiver dynamic range. Junction FETs in the balanced mixer, MOSFET RF amplifier at low level, and dual resonator for each band.
- Variable bandwidth tuning (VTB). Varies IF filter pass-band width.
- Notch filter (high-Q active circuit in 445kHz second IF).
- IF shift (passband tuning).
- Built-in digital display (six digits, fluorescent tubes), analog subdial, and display hold (DH) switch.
- Noise-blanker threshold level control.

- 6146B final with RF negative feedback. Runs 220W PEP (SSB)/180W dc (CW) input on all bands.
- Built-in RF speech processor.
- Narrow/wide filter selection on CW.
- SSB monitor circuit to check transmitted audio quality.
- RIT (receiver incremental tuning) and XIT (transmitter incremental tuning).

**OPTIONAL ACCESSORIES:**

- SP-230 external speaker with selectable audio filters.
- VFO-230 external digital VFO

with 20Hz steps, five memories, digital display.

- AT-230 antenna tuner/SWR and power meter/antenna switch, 160-10 metres, including three new bands.
- YG-455C (500Hz) and YG-455CN (250Hz) CW filters for 455kHz IF.
- YK-88C (500Hz) and YK-88CN (270Hz) CW filters for 8.83MHz IF. (VFOs for TS-830S, TS-130 Series, and TS-120S are compatible with all three series of transceivers.)

TS-830S £726.57 inc VAT. Carriage £4.50.



## TS530S *building on proven success*

The all new TS530S is firmly based on the reputation of the TS520 series and incorporates many of the features of the superb TS830S. Included are the three new bands and, of course, the rig has both digital and analogue frequency readout. Also available for the TS530 is a complete range of matching station accessories, the SP230 speaker, the VFO240 and, of course, the AT230 antenna tuning unit.

**TS530S features:**

- Single conversion receiver and transmitter using 8.83 MHz. I.F.
- LSB, USB and CW on 160-10 metres including the new 10, 18 and 24 MHz. bands.
- Built in digital display with 6 digits and also analogue dial.
- IF shift (passband tuning).
- RIT (Receiver Incremental Tuning) and XIT (Transmitter Incremental Tuning).
- Built in speech processor.
- Narrow and wide filter switching.
- Noise blanker threshold level control.
- Also retained are the rugged reliable 6146B PA valves and the easy to use controls.

**Optional Accessories**

- SP230 external speaker with selectable audio filters.
- VFO 240 external matching VFO.
- AT230 antenna tuner/SWR and power meter/antenna switch, 160 to 10 metres including the 3 new bands.



Have your thought about selling or trading in your QSL cards? Not so daft as it seems, since our collectomaniac Director — John Wilson — is willing to buy or trade in QSL cards. They must be postally used, in other words have stamps on, and been sent to you from abroad. Particular interests are cards from former African colonies and places like Ascension, St. Helena, and so on. If you are interested, why not contact John Wilson at Matlock; it's an easy way to turn waste paper into money.

**£561.20 inc VAT carriage £4.50**

**LE LOWE ELECTRONICS Ltd.**  
 CHESTERFIELD ROAD, MATLOCK, DERBYSHIRE. TEL. 0629/2817.

The

# SHORT WAVE

Magazine

Guest

50p

VOL. XXXIX

SEPTEMBER 1981

NUMBER 7

ANNIVERSARY 1971 - 1981

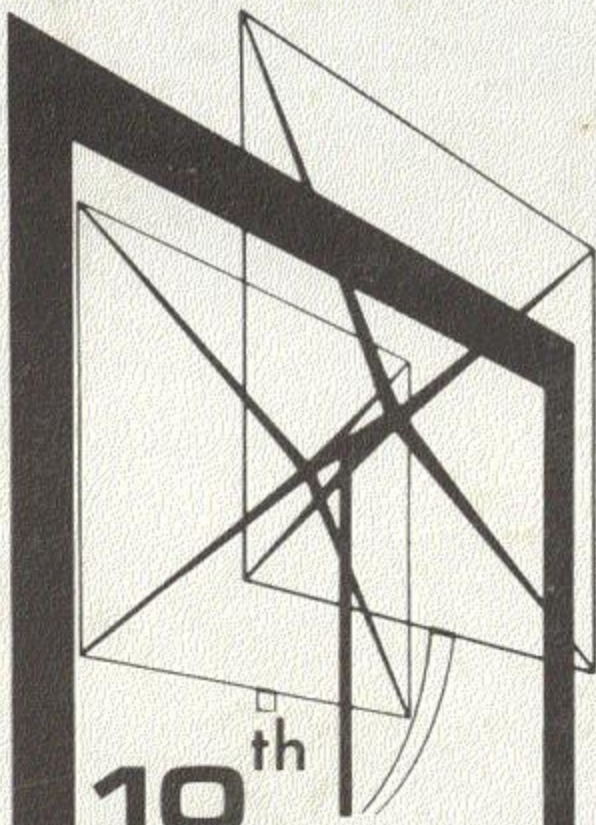

10<sup>th</sup>

NATIONAL  
AMATEUR  
RADIO  
EXHIBITION

THE AMATEUR RADIO RETAILERS ASSOCIATION

THIS YEAR AT

**DONINGTON PARK**

HOME OF THE DONNINGTON MOTOR MUSEUM

THURSDAY 29th OCTOBER

FRIDAY 30th OCTOBER

SATURDAY 31st OCTOBER

Open from 10 a.m. to 6 p.m.

Admission **£ 1.00**

(PARTIES OF 15 OR OVER 80p/PERSON)

Includes admission to the motor museum

NOTE CERTAIN DEALERS WILL BE REFUNDING ADMISSION COSTS ON SALES OVER £30.00

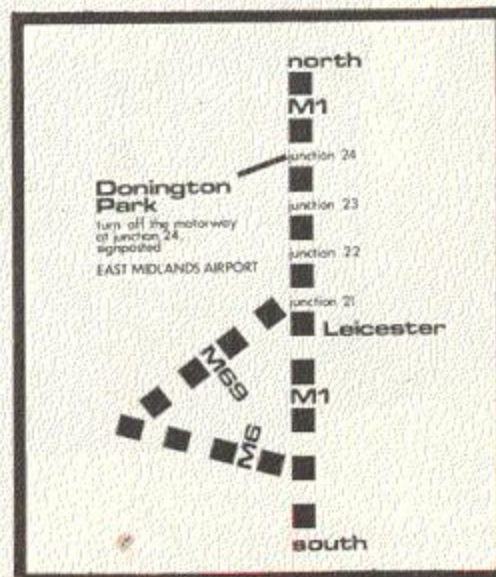

NOT AT  
LEICESTER  
THIS YEAR  
AT  
DONINGTON

### welcome to Donington

In 1971, following two or three years with no national amateur radio shows, a group of concerned dealers got their heads together and formed an association with the sole aim of putting on a really representative amateur radio exhibition in the Midlands. The result was the formation of the A.R.R.A. and the first National Amateur Radio Exhibition at the Granby Halls in Leicester.

Everyone now knows that the show went from strength to strength over the years, but in our tenth year it is obvious from comments received from visitors to the show that serious drawbacks arose as the attendance figures increased.

You will remember with horror, the state of Granby Halls at last year's show. No one could be content with such a place and we are delighted to tell you that the show has been moved this year to a superb new site at Castle Donington. All the problems of Leicester have been overcome by the move, and you will no doubt see the wisdom and necessity for leaving Granby Halls behind us.

### how to get there

Access to Donington is easy. Simply leave the M1 motorway at exit 24 (East Midlands Airport) and follow the signs to Donington Park. You need only travel about a mile and a half along quiet country roads; quite a contrast to fighting with Leicester city centre traffic.

### parking

Parking. You remember the parking in Leicester? At Donington Park there are 2½ acres of free parking right at the exhibition hall entrance. Say no more.

### facilities

Cleanliness. The main complaint by visitors and exhibitors alike. When you pass through the plate glass doors, cross the carpeted entrance hall and enter the well lit, clear, warm halls at Donington, you will be amazed at the difference. Facilities in general. Clean toilets and a well staffed permanent restaurant will be quite a change from Leicester, where you needed wellington boots before you dared venture into the toilets.

### for you

At Donington, all the main dealers and importers will be putting on an even bigger and better display of all the best for the Radio Amateur and Enthusiast. The only complaint is likely to be from wives and girl friends who may miss the stands selling dolls, balloons and souvenirs. The A.R.R.A. felt that these stands were not in keeping with Amateur Radio and, accordingly, have not allocated them space.

### plus

Add to all this the fact that since the new exhibition is taking place at the home of the Donington Motor Museum, and the entrance charge also includes entry to the Museum, you have full and free access to the one of the finest collections of historic motoring in the country.

# LOWE SRX30D

*a familiar name, but a whole new receiver*



A familiar name, but a whole new receiver behind it. Building on all the excellent features of the SRX-30, including the drift cancelling system covering 500 KHz to 30 MHz; the selectable sidebands and AM; the easy to use tuning system; we now introduce the all new SRX30D which incorporates the suggestions made by our customers. Outstanding new features are: —

- Extended coverage 200 KHz - 30 MHz.
- Digital readout in large green display units which give true unambiguous frequency information — even when you switch sidebands or use the clarifier.
- All new frequency sythesis using Plessey SL6 1641 double balanced modular ICs for a new high standard of performance.
- All new audio system which produces outstandingly good quality on the built in speaker, and is capable of driving external hi fi speaker units for even better sound.
- All new IF filters with optimum bandwidth for mode in use. Automatic filter selection from mode switch.

There is so much that is impressive about the SRX30D that you have to see it and handle it to really appreciate the performance.

We predict that the SRX30D will be a landmark in low cost, high performance SWL receivers. Just consider how much you should pay for a receiver covering 200 KHz - 30 MHz with accurate digital readout; high performance USB/LSB/AM with switched filters; drift cancelling frequency sythesis; built in mains supply and built in speaker; high quality construction and advanced design — and so much more.

Then look at our price for the SRX30D and you will be even more impressed.

**£195.00 inc VAT, Securicor carriage £4.50.**

### *Accessories for the short wave listener.*

		Inc VAT	Carr
HF5	80-10m vertical. No radials required when on ground post . . . . .	48.50	4.50
EIS	Small egg insulator. Glazed ceramic 40 cm long . . . . .	.30	.25
EIL	Large egg insulator. Glazed ceramic 50 cm long . . . . .	.45	.36
SIL	Ribbed strain insulator for dipole end or centre. 70cm long . . . . .	.35	.36
<b>MIZUHO</b>			
KX2	Top quality 500 Khz-30 mhz aerial tuner. Perfect match for R1000 . . . . .	29.90	1.50
AX1	Aerial switching system. Handles 6 aerials & 6 receivers . . . . .	27.03	1.00
APM1	Audio peak and notch filter. Variable bandwidth active filters . . . . .	33.00	1.00
SR1	Mini rack for above the system . . . . .	14.09	1.50
MP1	Rack mount for APM1 . . . . .	5.20	1.00

# TRIO

*pacesetter in amateur radio*



The Trio 9500, a 70 cm multimode mobile giving SSB, FM and CW operation in a compact rig. Add the spacious 70 cm band to your operating.

**TR9500** *70 cm multimode.*  
**£482.54 inc. VAT. Securicor carriage £4.50.**



TR-9000 The exciting TR-9000 2-metre all-mode transceiver combining the convenience of FM with long distance SSB and CW in a very compact, very affordable package. Because of its compactness the TR-9000 is ideal for mobile installation; add on its fixed station accessories and it becomes the obvious choice for your shack.

**TR9000** *2 metre multimode.*  
**£371.91 inc. VAT. Securicor carriage £4.50.**



TR-7800 Trio's remarkable TR-7800 2-metre FM mobile transceiver provides all the features you could desire for maximum operating enjoyment. Frequency selection is easier than ever, and the rig incorporates new memory developments for repeater shift, priority, and scan. The TR-7800 by Trio, the only FM mobile.

**TR7800** *2 metre FM rig.*  
**£276.00 inc. VAT. Securicor carriage £4.50.**

### HEAD OFFICE AND SERVICE CENTRE

Chesterfield Road, Matlock, Derbys. Tel. 0629 2817 or 2430.

Open Tuesday-Friday 9-5.30, Saturday 9-5.00. Closed for lunch 12.30-1.30.

For all that's best in ham radio, contact us at Matlock.

For full catalogues send 70p in stamps with your address. Mark enquiry SWM.





# SOUTH MIDLANDS COMMUNICATIONS LIMITED

S.M. HOUSE, OSBORNE ROAD, TOTTON, SOUTHAMPTON, SO4 4DN, ENGLAND  
 Tel: Totton (0703) 867333, Telex: 477351 SMCOMM G, Telegram: "Aerial" Southampton

Remember the 10th. Anniversary Amateur Radio Retailers Association Amateur Radio Exhibition has moved. It will NOT appear at Granby Halls. The new venue CASTLE DONNINGTON where cleanliness is of a far higher standard.

FULL RANGE OF MATCHING ACCESSORIES

## FT290R



**£229 inc.**

VAT @ 15% & POSTAGE

CSC1	£3.45	NC11C	£7.65	NC22C	£2.35
MMB11	£20.70	SMC2.2C	£2.70	FL2010	£59.75

- ★ 144-146MHz (144-148 possible)
- ★ Multimode USB, LSB, FM, CW
- ★ 2.5W PEP, 2.5W RMS/300mW out
- ★ LED's; 'ON AIR', 'BUSY'. MC meter; S.PO
- ★ Integral telescopic antenna
- ★ Bandwidth 2.4KHz and 14KHz @ - 6dB
- ★ Optically coupled main tuning
- ★ 100 Hz backlit LCD Frequency display
- ★ 10 memory channels "5 year" backup
- ★ FM: 25KHz and 12.5KHz steps
- ★ SSB: 1KHz and 100Hz steps
- ★ Any TX & RX split with dual VFO's
- ★ ±600KHz repeater split 1750Hz burst
- ★ Mobile mounting bracket available
- ★ Matching 10W linear Amplifier
- ★ Up/down tuning from microphone
- ★ AF output 1W @ 10% THD
- ★ 58 (H) x 150 (W) x 195 (D) (1.3kg)
- ★ Rx, .70mA, Tx; 800mA (FM maximum)
- ★ 8 'C' Ni cads or Drys. 8.5-15.2V DC External



## FRG7

- ★ "Industry standard" receiver.
- ★ 0.5-3MHz.
- ★ SSB (LSB/USB), CW, AM.
- ★ Selectivity of ±3kHz at - 6dB.
- ★ Wadley-loop triple conversion.
- ★ 10kHz Direct dial readout.
- ★ Well calibrated "sharp" preselector.
- ★ AM Automatic noise suppression circuit.
- ★ Antenna Hi to 1.6MHz, 50ohm to 30MHz.
- ★ 3 position RF attenuator.
- ★ 3 position AF filter (LP, WBP, NBP).
- ★ 110-240Vac and 12Vdc.
- ★ Lights: battery economy switch.
- ★ Illuminated edge type "S" meter.
- ★ Optional Battery holder £5.00.

**£199 inc.** VAT @ 15% & SECURICOR



## FRG7700

- ★ Incredible new receiver.
- ★ 0.15-30MHz.
- ★ SSB (LSB/USB), CW, AM, FM.
- ★ 2.7kHz, 6kHz, 12kHz, 15kHz, @ - 6dB.
- ★ Up conversion 48MHz first IF.
- ★ 1kHz digital plus analogue display.
- ★ No preselector, auto selected LPF's.
- ★ Advanced noise blanker fitted.
- ★ Antenna 500ohm to 2MHz, 50ohm to 30MHz.
- ★ 20dB pad plus continuous attenuator.
- ★ Constantly variable tone control.
- ★ 110 and 240Vac and 12Vdc option.
- ★ 12 channel memory option.
- ★ Signal meter calibrated in "S" and SIMPO.
- ★ FRG7700M £389. Memory option £83.95.

**£309 inc.** VAT @ 15% & SECURICOR

NEW MATCHING ATU, LPF AND FOUR VHF CONVERTORS

### SMC SERVICE

Free Finance on many items. Two year guarantee on Yaesu. Free Securicor on major Yaesu items. Access and Barclaycard over the telephone. Biggest Branch, Agent and Dealer network. Ably staffed, courteous, Service Department. "B Services" Securicor contract at £3.50!! Biggest stocks of amateur equipment in UK. Twenty-two years of professional experience.

### GUARANTEE

Yaesu's own warranty does not extend outside Japan. Repairs are the responsibility of the UK dealer selling the set. SMC's two year guarantee is backed, as UK distributors, by daily contact with the factory and many tens of thousands of pounds of spares and test equipment. Avoid hawkers offering sets without serial numbers, spares, service or advice back-up.

### FREE FINANCE

On regular priced items from; Yaesu, Ascot SMCHS, CDE, HyGain, Channel Master, Hansen, SMC, MFJ, KLM, Mirage and Hy Mound, on invoices over £100SMC offers Free Finance! How is it done? Simple, pay 20%, split the balance equally over 6 months or pay 50% down and split the balance over a year. You pay no more than the cash price!!

### YAESU MUSEN

As UK Agents, we show some major Yaesu items; a new VHF multimode handportable, 2 general coverage receivers, multimodes for VHF and UHF FM transceivers for VHF, UHF and VHF/UHF, 4 HF transceivers (SSB, CW, FSK, AM, FM) and a fistful of VHF and UHF handhelds. Remember there are 150 accessories to complement these lines . . .



## FT780R

- ★ 430-434 MHz (440-445 possible)
- ★ USB-LSB-CW-FM (A3J, A1, F3)
- ★ Input; 30W (PEP A3J + A1/F3)
- ★ GaAs Fet RF for incredible sensitivity
- ★ NMOS four bit micro control
- ★ Bandwidth 2.2KHz and 14KHz @ -6dB
- ★ 'Dial set' clears non integral steps
- ★ Very bright blue display to 100Hz
- ★ Display indicates Tx and Rx (inc RIT)
- ★ Manual tone switch on microphone
- ★ String LED displays for S and PO
- ★ Digital receiver independent tune ( $\pm 10$ KHz)
- ★ Advanced effective noise blanker
- ★ FM; 100KHz, 25KHz, 1KHz, steps
- ★ SSB; 1,000, 100, 10Hz steps
- ★ Repeater access by use of dual VFO's
- ★ Four easy write in memory channels
- ★ Memory scanning with slot display
- ★ Up/down tuning from microphone
- ★ Priority channel on any memory slot
- ★ Satellite mode allows tuning on Tx
- ★ Scanning for busy or clear channels
- ★ Size (case): 10" D, 2.3" H, 6.9" W
- ★ LED's on air, clear, hi/low, FM mod
- ★ FP80 mains PSU + SC1 console available

**£409 inc.** VAT @ 15%  
& SECURICOR



## CPU2500RS

- ★ Covers 144 to 146 or 148MHz
- ★ 25/3 watt or 10/1 watt model(s)
- ★ CPU controlled digital synthesiser
- ★ 10KHz (+ 5KHz up) synthesised steps
- ★ Optional 25KHz steps in St version
- ★ 6 digit readout + memory channel number
- ★ Main tuning, by optically coupled encoder
- ★ Up/down tuning/scanning from microphone
- ★ Scanning for empty or occupied channels
- ★ Band scanning up or down the band
- ★ Four normal memory channels
- ★ Further memory for 'odd' split
- ★ Can scan memory channels only
- ★  $\pm 600$ KHz plus any split (to 4MHz)
- ★ Sub audio tone squelch option
- ★ Manual (EU) and Auto (UK) tone burst
- ★ High or low (1/10) power switch
- ★ Low noise mosfet RF stage
- ★ LED's for: - 'on Air' and 'Busy channel'
- ★ VSWR and reverse polarity protection
- ★ Punch in frequency on keyboard mic (K)
- ★ 0.5A Rx, 2.5A LTx, 6 A HTx (25). 13.6V DC
- ★ Case; 7" wide, 2 3/4" high, 10 1/2" deep
- ★ Sensitivity: 1.3  $\mu$ V for 20dB
- ★ Selectivity: 12KHz  $\star -6$ bD (2:15F)

**£235 inc.** VAT @ 15%  
& SECURICOR



## FT720RV

- FT720 Control Head**
- ★ For easy write-in memory channels
  - ★ Rx priority channel (auto check)
  - ★ Scanning of band/memory for empty/busy
  - ★ Up/down tuning/scanning from mic.
  - ★ Optically coupled tuning control
  - ★ Manual and automatic tone burst
  - ★ String LED's for 'S' and PO, status LEDs
  - ★ 1 1/2 W of audio to internal/external speaker
  - ★ 3.3 (4.3)" D x 6" W x 2 (2.2)" H
  - ★ **720RV** 10W, 2M deck    **720RVH** 25W, 2M deck
  - ★ 144-146MHz (144-148MHz possible)
  - ★ 12 1/2 KHz sythesizer steps, 600kHz Shift
  - ★ 0.3  $\mu$ V for 20dB quieting
  - ★ Rx 0.5A, Tx RV 3.5A, RVH 6.5A
  - ★ 5.8 (6.5)" D x 6" W x 2 (2.2)" D
  - ★ **7209RU** 10W, 70cm. deck
  - ★ 430-434MHz
  - ★ 25KHz synthesizer steps, 1.6MHz Shift
  - ★ 0.5  $\mu$ V for 20dB quieting
  - ★ Rx 0.5A, Tx 4.5A
  - ★ 5.8 (6.5)" D x 6" W x 2 (2.2)" D
  - ★ **S72** Switching box
  - ★ Pushbutton bandswitching between two decks
  - ★ Auto change of synthesizer steps/splits

**£253 inc.** VAT @ 15%  
& SECURICOR



## FT480R

- ★ 144-146MHz (143.5-148.5 MHz possible).
- ★ USB-LSB-CW-FM (A3j, A1, F3).
- ★ 30W PIP A3j, 10/1 W our A1 F3.
- ★ Bandpass filter no tune design.
- ★ Excellent dynamic range sensitivity.
- ★ Bandwidth 2.4kHz and 14kHz at -6dB.
- ★ Semi break in with side tone.
- ★ Very bright blue 100Hz digital display.
- ★ Display shows Tx and Rx freq (inc RIT).
- ★ String LED display for "S" and PO.
- ★ Digital receiver offset tuning.
- ★ Advanced effective noise blanker.
- ★ FM; 25 1/2, 1kHz steps.
- ★ SSB; 1,000, 100, 10Hz steps.
- ★ Any TX Rx split with dual VFO's.
- ★  $\pm 600$ kHz standard repeater split.
- ★ Four easy write-in memory channels.
- ★ Memory scanning with slot location display.
- ★ Up/down tuning/scanning from mic.
- ★ Priority channel on any memory slot.
- ★ Satellite mode allows tuning on Tx.
- ★ Scanning for busy or clear channels.
- ★ Size (Case): 8.3" D, 2.3" H, 6.9" W.
- ★ LED's; "On Air" Clar, Hi/Low, FM model.
- ★ Matching PP80 Mains PSU available.

**£359 inc.** VAT @ 15%  
& SECURICOR



**FT101ZDFM**

- ★ 160-10 metres including new allocations.
- ★ Variable IF bandwidth 2.4kHz down to 300Hz.
- ★ 8 pole filters for razor edge selectivity.
- ★ Selectable CW fixed bandwidth CW-W and CW-N\*.
- ★ Semi-break in with sidetone for excellent CW.
- ★ Digital plus analogue frequency displays.
- ★ 6146B PA's with 6dB of negative feedback.
- ★ 180W PIP and - 31dB 3rd order intermod.
- ★ RF speech processor fitted - adjustable level.
- ★ VOX built-in and is adjustable from the front panel.
- ★ Wide dynamic range for big signal handling.
- ★ High usable sensitivity, for those weak ones.
- ★ Superb noise blanker - adjustable threshold.
- ★ Attenuator; 0-10-20dB, front panel switch.
- ★ AGC; slow-fast-off, front panel switchable.
- ★ Clarifier (RIT) switchable on TX, RX or both.
- ★ Low level transvertor drive output facility.
- ★ Universal power supply 110-234V AC and 12V DC\*.
- ★ Incredible range of matching accessories
- ★ 4 models; Digital/Analogue - AM/FM

FT101ZAM	£515.00inc.	SP901	
FT101ZFM	£529.00inc.	FV101Z	£121.90inc.
FT101ZDM	£585.00inc.	FV101DM	£225.00inc.
FT101ZDFM	£599.00inc.	FV901DM	£223.45inc.
FL2100Z	£385.25inc.	WMT101Z	£12.00

\*Option. **£599 inc.** VAT @ 15% & SECURICOR



**FT902DM**

- ★ 160-10 metres including new allocations.
- ★ Variable IF bandwidth 2.4kHz down to 300Hz.
- ★ Audio Peak and independent notch controls.
- ★ AM, FSK, USB, LSB, CW, FM, (TX and RX).
- ★ Semi-break in, inbuilt Curtis IC Keyer.
- ★ Digital plus analogue frequency displays.
- ★ 6146B's with negative feedback.
- ★ VOX built-in and adjustables.
- ★ Instant write in memory channel.
- ★ Tune up button (10 sec, of full power).
- ★ Curtis Keyer - lmbic, single or straight.
- ★ Switchable AGC and RF attenuator.
- ★ Optional 350 or 600 Hz CW, 6kHz, AM filters.
- ★ Clarifier (RIT) switchable on TX, RX or both.
- ★ Audio Peak and tunable notch filter.
- ★ Plug in modular, computer style constructor.
- ★ Fully adjustable RF Speech processor.
- ★ Ergonomically designed with necessary LEDS.
- ★ Incredible range of matching accessories.
- ★ Universal power supply 110-234V AC and 12V DC.

FT902DM	£799.00inc.	YR901	£369.00inc.
FT902DE	£713.00inc.	YVM1	£142.60inc.
FT902D	£724.50inc.	YK901	£115.00inc.
YO901P	£302.45inc.	FTV901(2)	£263.35inc.
FC902	£126.50inc.	WMT901	£12.00

\*Option. **£799 inc.** VAT @ 15% & SECURICOR



**FT107M**

- ★ 160-10 metres (including 10, 18, and 24Mhz).
- ★ USB-LSB-CWW-FSK-AM multi-mode.
- ★ Full broad band "no tune" power amplifier.
- ★ 240W PIP. 75 per cent power output at 3:1 VSWR.
- ★ 12 memory channels with clarifier on memory.\*
- ★ Digital Memory Shift gives offset from memory.\*
- ★ Up/down scanning control from microphone.\*
- ★ Variable IF bandwidth - 16 poles of selectivity.
- ★ Bandwidths: 6kHz\*, 2.4kHz-300Hz, 600Hz-300Hz.\*
- ★ Selectable CW "fixed" widths CW-W and CW-N.\*
- ★ Tunable Audio Peak (AFP) and Notch filter.
- ★ Diode ring mixer for very high Rx dynamic range.
- ★ Noise blanker - front panel adjustable threshold.
- ★ AGC; slow-fast-off switchable from the front panel.
- ★ Attenuator 0-20dB, plus RF gain on front panel,
- ★ RF speech processor fitted - front panel adjustable.
- ★ Digital (100Hz) plus analogue frequency displays.
- ★ Meter Reads; Vcc, Ic, ALC, Compression and SWR.
- ★ Semi-break in with side tone. Vox built in.
- ★ Choice of built-in or separate power supply units.

FT107M	£690.00inc.	FC107	£102.35inc.
FT107MDMS	£775.00inc.	FP107	£97.75inc.
FV107	£92.00inc.	FP107E	£106.95inc.
FTV107	£110.40inc.	Filters	£23.00inc.
SP107	£27.60inc.	WMT107	£12.00

\*Option **£690 inc.** VAT @ 15% & SECURICOR

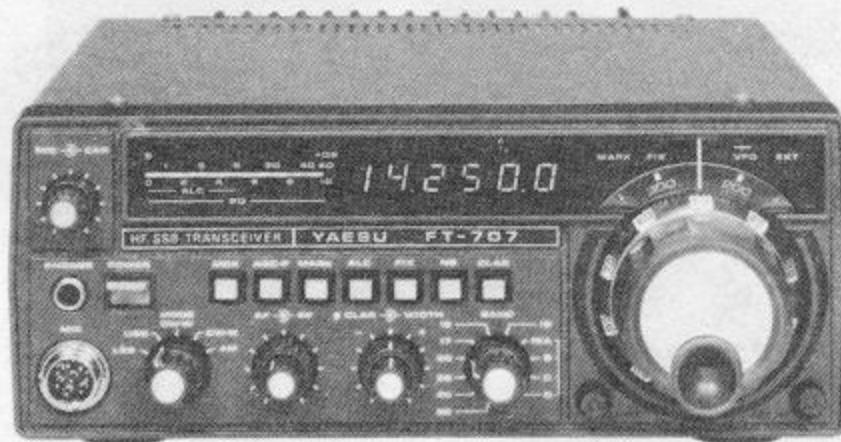

**FT707**

- ★ 80-10 metres (including 10, 18 and 24MHz bands).
- ★ USB-LSB-CWW-CWN-AM (Tx and Rx operation).
- ★ 100W PEP. 50% power output at 3:1 VSWR.
- ★ Full "broad band" no tune output stage.
- ★ Excellent Rx dynamic range, power transistor buffers.
- ★ Rx Schottky diode ring mixer module.
- ★ Local oscillator with ultra-low noise floor.
- ★ Variable IF bandwidth - 16 crystal poles.
- ★ Bandwidths 6kHz\*, 2.4kHz-300Hz (600-350)Hz\*-300Hz.\*
- ★ AGC; slow-fast switchable from the front panel.
- ★ VOX built-in and adjustable from the front panel.
- ★ Semi-break in with side tone for excellent CW.
- ★ Digital (100Hz) plus analogue frequency display.
- ★ LED Level meter reads: S, PO and ALC.
- ★ Convenient concentric AF/FR gain controls.
- ★ Indicators for: calibrator, fix, int/ext VFO.
- ★ Receiver offset tuning (RIT-clarifier) control.
- ★ Advanced noise blanker with local loop AGC.
- ★ 25kHz crystal calibrator feature.
- ★ Internal, xtal or external VFO control.

FT707	£529.00inc.	FTV707	£82.00inc.
FT707S	£455.00inc.	70TV	£80.50inc.
FP707	£109.25inc.	144TV	£101.20inc.
FC707	£80.50inc.	430TV	£175.95inc.
FV707DM	£186.30inc.	WMT707	£10.00

\*Option **£529 inc.** VAT @ 15% & SECURICOR

## FT208R

- ★ 144-148MHz (144-148 possible)
- ★ 12.5/25kHz synthesiser steps
- ★ 4 bit CPU synthesiser control
- ★ Keyboard entry of frequencies/splits
- ★ LCD digital display with backlight
- ★ Ten channels of memory
- ★ Memory back up '5 year lifetime'
- ★ Up/down manual tuning
- ★ Manual or auto scan for busy/clear
- ★ Priority channel with "check back"
- ★ Memory scanning feature
- ★ Scan between any two frequencies
- ★ Scan with auto pause/restart
- ★ Any split + or - programmable
- ★ Quick change NiCad pack
- ★ 1750Hz tone burst
- ★ ±600kHz repeater split
- ★ Built in condenser microphone
- ★ 500 mW AF to int/ext speaker
- ★ External speaker/mic option
- ★ 2.5 or 0.3W RF output
- ★ Rx; 20mA squelch 150mA max AF
- ★ Tx; 800mA at 2.5W RF
- ★ 0.25µV for 12dB SINAD
- ★ Dual conversion 16.9MHz & 455kHz
- ★ Keyboard provides 16 tone DTMF
- ★ 168 (H) x 61 (W) x 49 (D) mm
- ★ C/w NiCad pack and helical



**FT208R**  
**£195 inc.**  
 VAT @ 15%  
 & POSTAGE

## FT708R

- ★ 430-440MHz (440-450 option)
- ★ 25KHz synthesiser steps
- ★ 4 bit CPU chip frequency control
- ★ Keyboard entry of frequencies/splits
- ★ LCD digital display with backlight
- ★ Ten channels of memory
- ★ Memory back up 5 year lifetime cell
- ★ Up/down manual tuning
- ★ Manual or auto scan for busy/clear channels
- ★ Priority channel with search back
- ★ Memory scanning feature
- ★ Scan between any two frequencies
- ★ Auto scan restart
- ★ Any split + or - programmable
- ★ Quick change NiCad pack
- ★ 1,750Hz tone burst
- ★ ± 7.6MHz EU split standard
- ★ Built in condenser microphone
- ★ 500 mW AF to int/ext speaker
- ★ External speaker/mic available
- ★ 1W or 100 mW RF output
- ★ RX: 20mA squelch, 150MHz (max AF)
- ★ TX: 500 mA at 1W RF
- ★ 0.4µV for 12dB SINAD
- ★ Dual conversion 46.255MHz & 455KHz
- ★ Keyboard offers 16 tone DTMF
- ★ 168(H) x 61(W) x 49(D) mm.
- ★ C/w NiCad pack, helical



**FT708R**  
**£199 inc.**  
 VAT @ 15%  
 & POSTAGE

## FT207R

- ★ 144-148MHz (144-148 possible)
- ★ 12.5KHz synthesizer steps
- ★ 4 bit CPU chip for freq. control
- ★ Keyboard entry of frequencies
- ★ Keyboard lockout safety features
- ★ Digital display to hundreds of Hertz
- ★ Display auto shutdown timer
- ★ Four Channels of memory
- ★ Memory back up disable
- ★ Up/down manual tuning
- ★ Bandscan for busy or clear channels
- ★ Memory scanning features
- ★ ±600KHz split built in
- ★ Any split + or - programmable
- ★ Easy change Ni Cad packs
- ★ BNC antenna connector
- ★ "On Air" and "Channel Busy" LEDs
- ★ Built in condenser microphone
- ★ 200mW AF to internal/external speaker
- ★ External speaker/mic available
- ★ 2.5/0.2W of RF output
- ★ Rx; 35mA squelch, 150mA full vol.
- ★ Tx; 250mA low, 800mA high
- ★ 0.3µV for 20dB quieting
- ★ Double conversion 10.7MHz and 455KHz
- ★ Two tone encoder built in
- ★ 1.7 (2.2)" D x 2.5 (2.7)" W x 6.7 (7.2)" H
- ★ C/w NiCad pack, helical and case



**FT207R**  
**£175 inc.**  
 VAT @ 15%  
 & POSTAGE

## FT202R

- ★ 144-146MHz (144-148 possible)
- ★ 6 channel capability
- ★ 1 watt of FM RF output minimum
- ★ Rx; 30mA/200mA — squelch/500mW AF
- ★ Tx; 400/500mA — 300mW/1W
- ★ Dual Conversion 10.7MHz and 455kHz
- ★ 67 x 49 x 171mm
- ★ Built in speaker and mic, remote option
- ★ Operates on 'AA' NiCads or dries
- ★ C/w helical, case, xtalled S20, 21, 22



**FT202R**  
**£109 inc.**  
 VAT @ 15%  
 & POSTAGE

## FT404R

- ★ 430-440MHz (Tx 2MHz, Rx 5MHz Spread)
- ★ 6 Channel capability
- ★ 2.5W of FM RF output
- ★ Rx; 7mA/160mA — squelch/400mW AF
- ★ Tx; 400/500mA — 200mW/2.5W
- ★ Dual conversion 21.4MHz and 455KHz
- ★ 68 x 55 x 171mm
- ★ Built in speaker and mic, remote option
- ★ Operates on quick charge NiCad pack
- ★ C/w NiCad pack, helical, case, 1 Channel

**FT404R**  
**£179 inc.**  
 VAT @ 15%  
 & POSTAGE



# SOUTH MIDLANDS COMMUNICATIONS LIMITED

S.M. HOUSE, OSBORNE ROAD, TOTTON, SOUTHAMPTON, SO4 4DN, ENGLAND  
 Tel: Totton (0703) 867333, Telex: 477351 SMCOMM G, Telegram: "Aerial" Southampton

### AGENTS: G, GW, GM, GI, GJ.

G3ZUL	Brian	Stourbridge	(03843) 5917
GI3KDR	John	Bangor	(0247) 55162
GM9GEC	Jack	Edinburgh	(031665) 2420
GI3WVY	Mervyn	Tandragee	(0762) 840656
GW3TMP	Howarth	Pontybodkin	(035287) 846/324
GW8EBB	Peter	Swansea	(0792) 872525
GJ4CD	Geoff	Jersey	(0534) 26788
G4EQS	Simon	Redcar	(0642) 480808

### LEEDS

S.M.C. (Leeds)  
 Colin Thomas, G3PSM  
 257 Otley Road,  
 Leeds 16, Yorkshire.  
 Leeds (0532) 782326  
 9-5.30 Monday-Saturday

### CHESTERFIELD

★ S.M.C. (Jack Tweedy) LTD  
 N Roger Baines, G3YBO  
 E 102 High Street,  
 W New Whittington,  
 Chesterfield (0246) 453340  
 ★ 9-5.00 Tuesday-Saturday

### WOODHALL SPA

★ S.M.C. (Jack Tweedy) LTD  
 N Jack Tweedy, G3ZY  
 E 150 Horncastle Road,  
 W Woodhall Spa, Lincolnshire.  
 Woodhall Spa (0526) 52793  
 ★ 9-5.00 Tues.-Sat. (+ appointments)

# AMATEUR ELECTRONICS UK



Your number one source  
for **YAESU MUSEN**



**NEW**

**FT-101ZD  
Mk. III**

Now from YAESU comes the latest version of the renowned FT-101 - AM/FM option, notch filter, audio peak filter, variable bandwidth - UNBEATABLE VALUE

**FT-480R High technology all-mode 2 metre mobile**



The most advanced 2 metre mobile available today - USB, LSB, FM, CW full scanning with priority channel, 4 memory channels, dual synthesized VFO system.

**FT-707 All solid-state HF mobile transceiver**

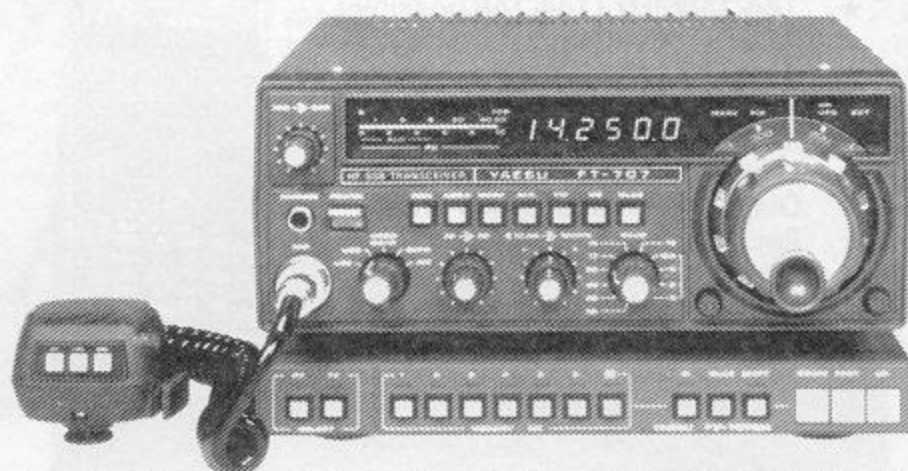

The definitive HF mobile rig, digital, variable IF bandwidth, 100watts PEP SSB. AM, CW (pictured here with 12 channel memory VFO).

As factory appointed distributors we offer you - widest choice, largest stocks, quickest deal and fast sure service right through -



or attractive H.P. terms readily available for on-the-spot transactions. Full demonstration facilities. Free Securicor delivery.

**FT-707 In base station format**



Here we show the 707 together with the matching FP-707 PSU, FC-707 ATU and FV-707DM VFO memory.



For full details of these new and exciting models, send today for the latest YAESU CATALOGUE and LEAFLETS. All you need to do to obtain the latest information about these exciting developments from the world's No. 1 manufacturer of amateur radio equipment is to send 36p in stamps and as an added bonus you will get our credit voucher value £3.60 p - a 10 to 1 winning offer.



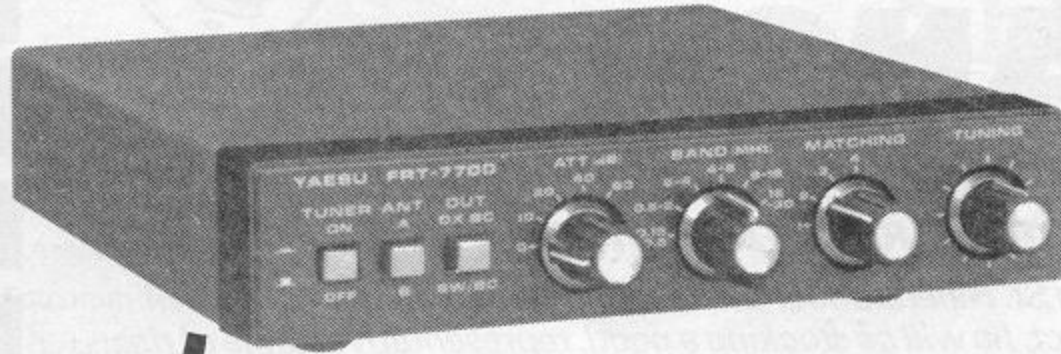

FRT-7700

## ATTENTION FRG-7700 owners!

Exploit the full potential of your receiver with YAESU's new FRT-7700 antenna tuner and FRV-7700 converter.

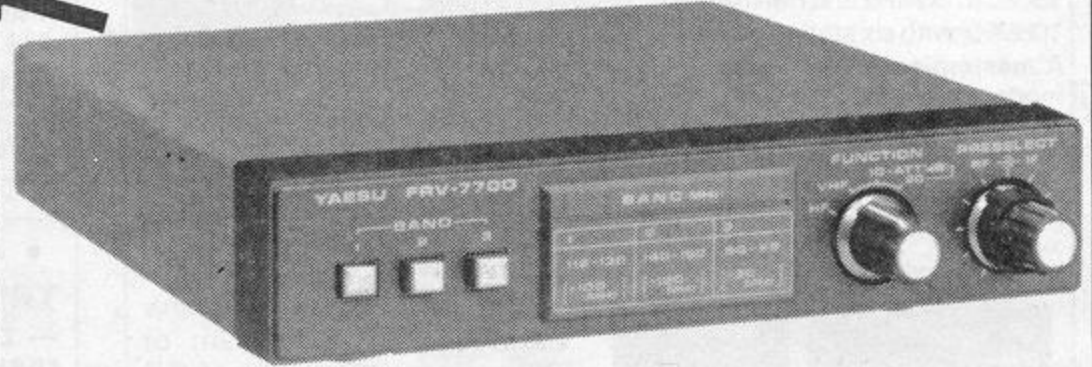

FRV-7700

### New on two!

FT-290R All-mode 2m portable



10 memories, 2 VFO's, LCD display, C size battery, easy car mounting tray, 2.5 watts out.

### New on seventy!

FT-780R All-mode 70 cm mobile



4 memories, memory and bandscan from microphone, conservative 10 watts out - All the features of the FT-480 on 70cm.

### AGENTS

NORTH WEST - THANET ELECTRONICS LTD, GORDON, G3LEQ, KNUTSFORD (0565) 4040.  
 WALES & WEST - ROSS CLARE, GW3NWS, GWENT (0633) 880 146.  
 EAST ANGLIA - AMATEUR ELECTRONICS UK - EAST ANGLIA, DR T. THIRST (TIM) G4CTT, NORWICH 06925 865  
 NORTH EAST - NORTH EAST AMATEUR RADIO, DARLINGTON 0325 55969  
 SOUTH EAST - AMATEUR ELECTRONICS, UK - KENT, KEN McINNES, G3FTE, THANET (0843) 291297

### WHERE TO FIND US

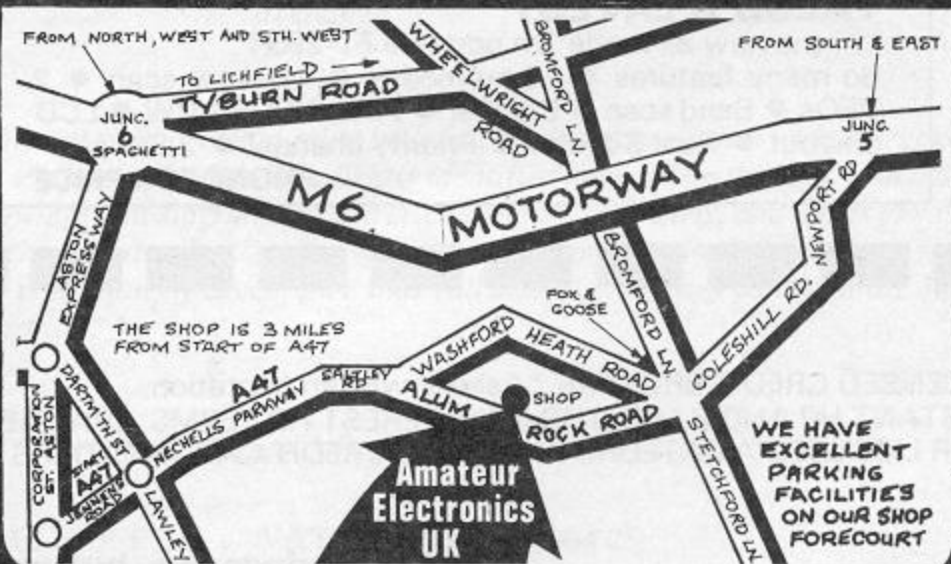

### Amateur Electronics UK

508-516 Alum Rock Road - Birmingham 8  
 Telephone: 021-327 1497 or 021-327 6313

Telex: 337045

Opening hours: 9.30 to 5.30 Tues. to Sat.  
 continuous - CLOSED all day Monday.

# AMATEUR RADIO EXCHANGE



## A SPECIAL ANNOUNCEMENT THIS MONTH FOR OUR FRIENDS AND CUSTOMERS IN THE NORTH WEST.

Our first branch outside London is about to open in St. Helens under the management of that well-known technical wizard Mike, G8EWU. As you would expect, he will be stocking a good, representative range of rigs by YAESU, ICOM and TRIO/KENWOOD plus a wide selection of accessories.

We promise you will be made as welcome at 136 Gladstone Street, St. Helens (near the Rugby ground) as you always have been at Ealing. The only thing missing will be Brenda's coffee!

### SONY ICF-2001

This unique HF communications receiver with keyboard entry and LCD covers AM/SSB/CW from 150kc to 30MHz and FM from 76-108MHz with six station memories. A masterpiece of compact modern technology at only

£159.



### FT-101 MK.III

The tried and tested Yaesu HF base station, now with audio peak filter and reject/notch filter as standard, and choice of AM or FM.

PHONE FOR PRICES INCLUDING FREE COOLING FAN AND MIC.

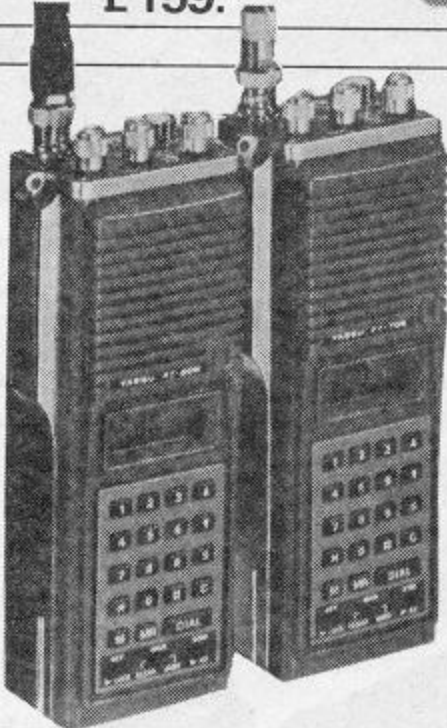
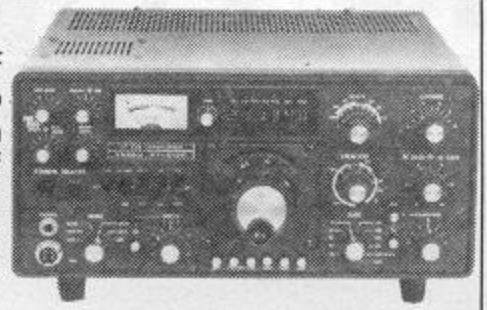

### FT-208R/FT-708R

Yaesu's marvellous new hand-held for either 2m or 70cm operation. Its LCD display (with night-lamp feature) is coupled to a 4-bit microprocessor giving 10 memories, up/down scanning in 25 or 50kc steps (manual or auto) plus memory scan and scanning between two desired frequencies, priority channel with search-back, keyboard entry allowing split frequency for non-standard repeaters . . . and lots more.

PHONE FOR PRICES

### TRIO/KENWOOD — LATEST MODEL IMPROVEMENTS

Three best-sellers in the range up-rated with new model designations. The TS-520 and TS-820 become the TS-530S and TS-830S respectively, both with all the new bands, IF shift etc. . . . and the TR-7800 becomes the TR-7850, now giving 40W out.

PHONE FOR PRICES

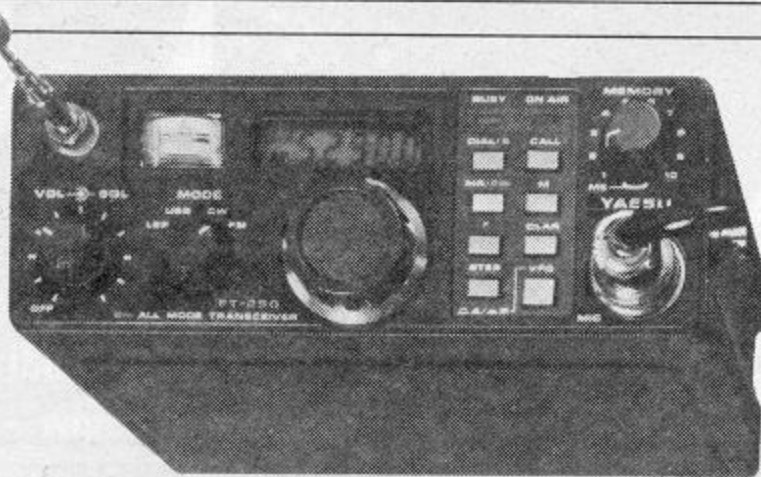

### YAESU'S LATEST

. . . the new all-mode 2m portable FT-290R. So many features • 10 memories • Memory scan • 2 VFOs • Band scan • Clarifier • FM/LSB/USB/CW • LCD readout • Real S-meter • Priority channel • 2.5W out.

PHONE FOR PRICE



### FRG-7700

Yaesu's latest receiver with FM right across the band now offers all these optional extras • Memory facility • FRT-7700 Aerial Tuning Unit at only £34.75 • Four VHF converters running from 50MHz up to 170MHz.

BASIC RECEIVER £299 inc. VAT and FREE HELISCAN AERIAL.

Converter specifications • Phone for prices.

FRV-7700A	118-130MHz	130-140MHz	140-150MHz
FRV-7700B	118-140MHz	140-150MHz	50-60MHz
FRV-7700C	140-150MHz	150-160MHz	160-170MHz
FRV-7700D	118-130MHz	140-150MHz	70-80MHz

LICENSED CREDIT BROKERS \* Ask for written quotation.  
INSTANT HP AND 6-MONTHS NO-INTEREST HP TERMS AVAILABLE  
FOR LICENSED AMATEURS AND BANK/CREDIT CARD HOLDERS



Credit card sales by telephone

Because of currency fluctuations etc. some prices are unknown as we go to press, and others may vary by publication date. Please phone for latest information.

All prices include VAT, but p&p/carriage are extra.

Closed Wednesday, but use our 24-hour AnsaFone service.

2 NORTHFIELD ROAD, EALING, LONDON, W13 9SY TEL: 01-579 5311

So easy for Overseas visitors. Northfields is just seven stops from Heathrow on the Piccadilly Line.

## ADVERTISERS' INDEX

	Page
Amateur Electronics UK ... ..	354, 355
Amateur Radio Exchange ... ..	356
Amateur Radio Exhibition... ..	385
Amateur Radio Retailers Association ... ..	397
Amcomm Services ... ..	386
J. Birkett ... ..	398
Bredhurst Electronics ... ..	358
British National Radio and Electronics School ... ..	390
Catronics Ltd. ... ..	393
Cambridge Kits ... ..	391
Colomor Electronics Ltd. ... ..	396
Datong Electronics Ltd. ... ..	345
Gemini Communications ... ..	394
G2DYM Aerials ... ..	396
G3HSC (Rhythm Morse Courses) ... ..	396
G3SRX & G8WCD Productions ... ..	400
Heathkit ... ..	395
D. P. Hobbs Ltd. ... ..	400
K. W. Communications Ltd. ... ..	392
Lee Electronics Ltd. ... ..	392
Leeds Amateur Radio ... ..	388
Lowe Electronics <i>front cover,</i> <i>inside front cover,</i>	341
Lutterworth Press ... ..	398
M & B Radio ... ..	399
M.H. Electronics ... ..	396
Newnes Technical Books ... ..	394
Northern Communications ... ..	390
North West Communications ... ..	393
P. J. Communications ... ..	400
P.M. Electronics Services ... ..	391
Quartslab Marketing Ltd. ... ..	398
Radio Shack Ltd. ... ..	387
Royal Air Force Association ... ..	399
R. T. & I. Electronics Ltd. ... ..	399
S.E.M ... ..	397
Small Advertisements ... ..	394, 395, 396
South Midlands Communications Ltd. ... ..	350, 351, 352, 353
Spacemark Ltd. ... ..	400
Stephen-James Ltd. ... ..	344
S.W.M. Publications <i>back cover,</i> <i>inside back cover,</i>	396, 400
Thanet Electronics Ltd. ... ..	346, 347, 348, 349
T.M.P. Electronics ... ..	391
Tuition ... ..	400
Uppington Tele/Radio (Bristol) Ltd. ... ..	396
Reg Ward & Co. Ltd. ... ..	399
Waters & Stanton Electronics ... ..	342, 343
Geoff Watts ... ..	400
Western Electronics (UK) Ltd. ... ..	388, 389
W. H. Westlake ... ..	396
Williamsons ... ..	400

# SHORT WAVE MAGAZINE

(GB3SWM)

ISSN: 0037-4261

Vol. XXXIX

SEPTEMBER, 1981

No. 455

## CONTENTS

	Page
VHF Bands, by N. A. S. Fitch, G3FPK .....	359
An Attic Beam for 7 MHz, by F. C. Smith, GW2DDX .....	363
"SWL" — Listener feature .....	364
Courses for the R.A.E., 1981-82 .....	367
Circuit Operation and Alignment of the FRG-7 Receiver, Part I, by J. L. Linsley Hood, MIEE, MIMC .....	368
A High Performance Power Supply and Control System for 4CX350/4CX250 Amplifiers, Part IV, by John H. Nelson, G4FRX .....	373
Clubs Roundup, by "Club Secretary" .....	377
"A Word in Edgeways" — Letters to the Editor .....	381
Communication and DX News, by E. P. Essery, G3KFE .....	382

Editor: PAUL ESSERY, G3KFE/G3SWM

Advertising: Charles Forsyth

Published at 34 High Street, Welwyn, Herts. AL6 9EQ, on the last Friday of the month, dated the month following.  
Telephone: 04-3871 5206 & 5207

Annual Subscription:

Home: £7.50, 12 issues, post paid  
Overseas: £7.50 (\$17.00 U.S.), post paid surface mail

Editorial Address: Short Wave Magazine,  
34 High Street, Welwyn, Herts. AL6 9EQ, England.

Prices shown in advertising in this issue do not necessarily constitute a contract and may be subject to change.

## AUTHOR'S MSS

Articles submitted for Editorial consideration must be typed double-spaced with wide margins on one side only of A4 sheets. Photographs should be lightly identified in pencil on the back with details on a separate sheet. All drawings and diagrams should also be shown separately, and tables of values prepared in accordance with our normal setting convention — see any issue. Payment is made for all material used, and it is a condition of acceptance that full copyright passes to the Short Wave Magazine, Ltd., on publication.

Short Wave Magazine Ltd.

E. & O. E. VAT Reg. No. 239 4864 25

**WE NOW STOCK DATONG PRODUCTS**

# Bredhurst electronics

HIGH ST., HANDCROSS, W. SUSSEX O444 400786



2 VFO's - 10 MEMS - 2.5W - SCAN - DIG. READOUT

**YAESU  
2M  
FT 290 R**  
PORTABLE  
MULTIMODE  
Price about  
**£229**

## NEW STANDARD TWINS

**C78 70cm FM Portable**  
£219 inc. VAT.  
**C58 2M. Multimode**  
£247 inc. VAT.

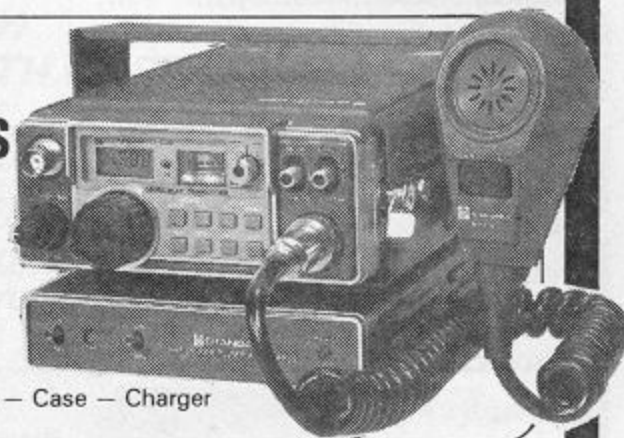

Accessories - Mobile Tray - Linear - Case - Charger

**YAESU**

**FT 208**

2M Handheld

**NEW**

**£190**  
inc. VAT

## AIR BAND RECEIVERS

**R517**

**£49.50**  
inc. VAT.

Tunes  
118-144 MHz

## V.H.F. SCANNERS



**SX 200N**  
£264 inc. VAT. & carriage



**BEARCAT 220FB**  
£258 inc. VAT. & carriage

## H.F. RECEIVERS



**TRIO  
R1000**  
£305  
inc. VAT & carr.

### TRANSCEIVERS

#### H.F.

Trio TS 130V	£450
Swan 100 MX	£418
Yaesu FT 707S	£454
Trio TS 130S	£547
Trio TS 530S	£561
Yaesu FT 101Z Mk.III	£529
Yaesu FT 707	£529
Yaesu FT 101ZD Mk.III	£599
Swan Astro 150	£613
Trio TS 830S	£726
Yaesu FT 107M	£690
Swan 102 BX	£798

#### 2M F.M. MOBILES

F.D.K. Multi 700EX	£189
Azden PCS 3000	£219
Icom IC 255E	£255
Trio TR 7800	£276
Trio TR 8400(70cm)	£329
Trio TR 7730	£p.o.a.

#### HANDHELD F.M.

Icom IC 2E	£169
Yaesu FT 208R	£190
Trio TR 2300	£166
Trio TR 2400	£198
Standard C78 (70cm)	£219

#### MULTIMODES

Standard C58 (portable)	£247
Yaesu FT 290R (portable)	£229
F.D.K. Multi 750E	£289
Icom IC 260E	£339
Trio TR 9000	£371
Yaesu FT 480R	£359
Icom IC 251E	£479
Trio TR 9500	£482

### RECEIVERS

#### H.F.

Yaesu FRG 7	£189
Lowe SRX 300	£195
Trio R1000	£305
Yaesu FRG 7700	£309
Yaesu FRG 7700M with memories	£389
J.R.C. NRD 515 (The Best!)	£948

#### 2M F.M./MARINE

Search 9	£45
A.O.R. AR22 (2M only)	£83
F.D.K. TM568	£89
SX 200N Scanner	£264
Bearcat 220FB Scanner	£258

#### AIRBAND

R 517 Handheld	£49.50
Bearcat 220FB Scanner	£258
SX 200N Scanner	£264

### ACCESSORIES

#### POWER SUPPLIES

13.8v Fully Protected - for peace of mind!

4 Amp Continuous	£27.95 (£1.50)
6 Amp Continuous	£44.95 (£2.00)
12 Amp Continuous	£69.00 (£2.50)
24 Amp Continuous	£99.00 (£5.00)

#### MORSE EQUIPMENT

HK 707 Up/Down Key	£10.50 (£0.50)
MK 704 Squeeze Paddle	£10.50 (£0.50)
EK 121 Elbug	£29.95 (£0.75)
EKM 12 Matching side tone monitor	£10.95 (£0.50)
EK 150 Electronic Keyer	£74.00 (-)
EK 1024 Memory Keyer	£126.00 (-)

### ACCESSORIES

#### SAFETY MICROPHONES

Adonis MM202S Clip on	£20.95 (£0.50)
Adonis MM202H Head band + Up/Down	£29.00 (£0.50)
Adonis MM202FU Swan neck + Up/Down	£30.00 (£0.50)
Daiwa RM940 Infra red link	£45.00 (£0.50)

#### DESK MICROPHONES

Yaesu YM 34 (Dual Impedance)	£18.80 (£1.50)
Trio MC 50 (Dual Impedance)	£25.76 (£1.50)
Shure 444D (Dual Impedance)	£29.95 (£1.50)
Shure 526T series II Power Mic	£39.95 (£1.50)
Adonis AM 502 Compressor Mic	£39.00 (£0.75)
Adonis AM 802 Compressor Mic. 30P's	£59.00 (£0.75)

#### TEST EQUIPMENT

Drac Wave Meter 130-450MHz	£24.95 (-)
FX1 Wave Meter (700K-250MHz)	£28.00 (£0.75)
Trio DM 801 Dip Meter (Up to 250MHz)	£51.00 (£0.75)

#### DUMMY LOADS

DL20 (30W max) PL 259	£5.00 (£0.50)
DL60 (60W max) PL 259	£8.80 (£0.50)
DL60 (60W max) N Type	£16.50 (£0.50)
DL150 (150W max) PL 259	£14.95 (£0.75)
DL1000 (300W Cont. 1KW max) PL259	£29.95 (£1.50)

#### TVI PROBLEMS

Yaesu FF501 DX Low pass filter (1KW)	£22.25 (£0.75)
Trio LF 30A Low pass filter (1KW)	£18.40 (£0.75)
TVI 30 Low pass filter (150W)	£5.95 (£0.60)
HP 4A High pass filter (TV down lead)	£5.95 (£0.50)
Ferrite Rings. Top quality 1 1/2" dia (per pair)	£0.80 (£0.20)

**MAIL ORDER - RETAIL CALLERS 9-5.30 PM.**  
**HIGH ST., HANDCROSS, W. SUSSEX. 0444 400786**

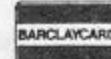

TO ORDER ANY OF THE ABOVE ITEMS SIMPLY WRITE ENCLOSING A CHEQUE OR PHONE YOUR CREDIT CARD NUMBER

all prices correct at time of going to press

# VHF BANDS

NORMAN FITCH, G3FPK

## What a Month!

**J**ULY 1981 must surely go down in VHF history bringing the tremendous *Sporadic E* opening to Iberia, North Africa and the Canary Islands on the 10th, the very intense *Aurora* on the 25th, and the superb tropospheric opening to Central Europe on the 30th and 31st. But first to other topics.

## Awards News

Mark Seaman, G8TRW, from Hawkwell in Essex, became the 340th member of the 2m. VHF Century Club on July 23. His radio interest started at the age of seven when a crystal set was built on a piece of wood, using nails to dress the components leads. In 1975, an old short wave Rx., 2m. converter and dipole were acquired for £25 enabling more serious listening on VHF to be undertaken. Mark took the *R.A.E.* in May, 1979 and then, "The big moment arrived about 0730 on October 9th when the licence arrived, marked simply, G8. Frantic telephone calls produced the 'TRW' suffix an hour or so later. . . ."

The first station comprised an *FDK* Multi-2700 with Rx. preamp. and a 4-ele. *Quad* in the loft from Rayleigh in Essex. Mark moved to the present QTH on Christmas Eve last year, the station now being an *Icom* IC-202 and *Parabeam* aerial. A 25 watts amplifier caused TVI, but a 4CX250B amplifier is contemplated with a 16-ele. *Yagi*.

John Hunter, G3IMV, was awarded his "225" squares sticker for QTHCC Certificate No. 3 on July 15. Eight of the new squares were worked on SSB, the rest on CW. Nine were tropo. QSOs, three *via Ar*, eleven by MS and two *via E*'s. One QSL was dated June 1975, proving a need for extreme patience!

## Beacons

On 4m. the new, solid state Gibraltar beacon, ZB2VHF, is now operational on 70.12 MHz on a continuous basis, from XW64g. The 4m. Angus beacon, GB3ANG, (YQ35c) could be operational a week or two after this appears on 70.690 MHz. The Tx. is ready and the licence has been issued but Chris Tran, GM3WOJ, has to sort out some installation problems yet. The 4m. beacon, GB3SU, on 70.695

MHz has recently come back on the air.

The Cornish 2m. beacon, GB3CTC, on 144.915 MHz is off the air now that its keeper has retired. To date, the *RSGB* has not been able to find anyone to assume responsibility for this very useful. Tx. So if any reader can help, please contact Society Headquarters.

## Contest Notes

**Results:**— The results of the Barking Radio and Electronics Society's 144 MHz Contest, held on March 29, have been received. Section 1 was won by the Swindon and District ARC, G8SRC/P, with 8,910 points, with the Mowcop and District ARC, G4HRO/P, in second place with 8,477 pts. John Brakespear, G8RZP, came third with 7,785 pts. from the previous, Berkshire QTH. Winner of the Essex stations section was the Mudhoppers Contest Group, G4DEZ/A, who clocked up 8,736 pts. John Lemay, G8KAX/P, was second with 5,560 pts., and Chris Smart, G8OCV/A, third with 3,630 pts. Only two *s.w.l.*'s sent in logs. R. Thomas (London) scored 1,909 pts. and N. Henbrey (E. Sussex) made pts. and N. Henbrey (E. Sussex) made 792 pts.

**Coming Events:**— The 2m. Contest is on Sept. 5/6, 1600-1600 GMT — see last month's feature. Saturday, Sept. 26, 1900-2300 GMT sees the last 1981 AGCW-DL Contest on 144 MHz for single operators. Scoring rules and exchanges as p. 38 of the March issue. (Up to July 26, DK3UZ had not received *any* British entry for the June event).

The Oct. 3/4 weekend is when the *RSGB*'s UHF/SHF Contests take place on all bands from 432 MHz to 24 GHz. This one coincides with the IARU Region 1 event and both are two section affairs, Single or Multi-operator.

## The Mizuho SB2M

Mention was made in the July column of spurious emissions from the little *Mizuho* SB2M 2m. transceiver. A reader also had similar trouble with his and it was caused by the VXO tuning capacitor which was a rather mediocre quality component of the type found in cheap, transistor radios. This caused instability of the main signal and the generation of nasty "sproggy" in various parts of the band. Replacement of this component cured this fault in an otherwise well-made transceiver.

## Satellite News

The next major event in the amateur satellite program will be the launch of *UOSAT*. As we go to press, the date is likely to be September 12 at 1141 UTC, from the Western Test Range at Vandenberg, California. There is only a six minute launch window and, if there is a hold up in the countdown to lift off of the *NASA Delta 2310* launch vehicle, another attempt could be made on Sept. 15 at the

same time.

There will be a 2m. net on 144.280 MHz in the London area from 1030 GMT as well as an *AMSAT* one on 3,780 kHz. There will be a direct telephone line between Vandenberg and the University of Surrey team in Guildford and the *ALINS* net will be on 14,280 kHz and possibly 21,280 kHz for those wishing to listen "first hand". If all goes to plan, the spacecraft should separate from the launcher at 1230 UTC over the Sudan, to achieve a 98 minute orbit, with an inclination of 97.5° at an altitude of 530 kms.

*UOSAT* is not a transponding spacecraft but will carry several unique experiments which listeners will be able to monitor with suitable equipment. Fuller details will be published in later issues of *Short Wave Magazine* once it is established that everything is working properly.

As for *Oscar 7*, nothing has been heard of it up to the time of editing this month's column, so it really does seem to have died after well over six years of reliable service, far exceeding its expected transponding life. *O-8* is now the only amateur orbiting transponder operating. The new calendar for it and other satellites should be available from *AMSAT-UK* by the time this appears. All inquiries to:— Ron Broadbent, G3AAJ, 94 Herongate Rd., London E12 5EQ, enclosing an *s.a.e.* please.

## Four and Six Metres

Syd Harden, G2AXI, (Hants.) has been concentrating on 4m. and has so far got 55 counties and 8 countries this year. VHF NFD came in handy and on July 25, EI9BG, (Co. Clare), EI6DT, (Dublin) and G5KW, (Scillies) were added. Bill Hodgson, G3BW, (Cumbria) heard ZB2VHF during the afternoon and late evening of July 30 at S8/9 but no *E*'s apparently. Martin Blythe, G4HFO, (Cornwall) also heard ZB2VHF up to S9 for 3 hours on Aug. 2. He is looking for contacts on 4m. and is QRV on Sunday mornings.

Peter Turner, G3IIL, (Brighton) used his "... ever faithful *FT-200* and *Magnum Four* ..." from a tent by Devil's Dyke during NFD and worked 85 stations, best DX being GM3WOJ/P. An unexploded object in the tent turned out to be a smoke flare. Peter had been using it to tap his pipe on! He has bought some of the excellent *T.W.* 4m. gear for use at the Brighton QTH, running 10 watts of CW and AM, crystal controlled on 70.26 MHz. Any reader with surplus *T.W.* gear should contact G4IIL at Flat 6, 132 Marine Parade, Brighton, E. Sussex. The last signals from Africa on 6m. were logged on May 28 (up to July 8) but the ZB2VHF and 5B4CY beacons have been copied well recently.

Ken Ellis, G5KW, will be operating from the Isles of Scilly until mid-



December, returning again in the Spring. He is a keen 10/6m. crossband operator with 22 countries and 42 U.S. states worked so far. His 6m. station comprises an Icom IC-551 transceiver and Cushcraft 617-6B aerial on a 34ft. boom, with a Yaesu FT-620B as back-up. The new ZB2VHF beacon on 70.12 MHz was copied from 1130 on July 19, peaking S9. G4JCC telephoned ZB2BL at 1800 and shortly after, Jimmy came on to work him, then G5KW, G4BPY, EI6AS, G3COJ and a few others. Ken, with the backing of the Council of the Isles of Scilly, has put up a case to the Home Office for a GS prefix for the islands.

Arthur Breese, GD2HDZ, added a dozen 1981 counties during NFD, plus GW3YET (Gwynedd) and GM4DIJ (Lothian) later in July. Clive Smith, GM4FZH, writes that he and Helen, GM4KNQ, are now QRV from Halkirk, Caithness, (YS33d) using a Yaesu FT-101ZD and MMT 70/28 transverter with a 4-ele. beam on 4m. A PA is promised when time permits its building. During the July 25 *Ar* Clive worked G3UKV, G4BPY and G3JYP on CW. Roy Webb, GW3CBY, (Swansea) was also on during the *Ar* and boosted his table score nicely.

John Baker, GW3MHW, (Dyfed) reports frequent reception of ZB2VHF on 50.035 MHz, presently using A1 keying to keep the temperature down. He mentions odd harmonics from commercial links around 50.035-50.500 MHz and suggests listeners check at one-half and one-third these frequencies to try to identify the signals. John has been running his 4m. and 6m. receivers simultaneously on the ZB2VHF beacons and finds the fading patterns are different. He mentions the advantage of having both vertical and horizontal polarisation available to combat fading on 6m. DX signals. To avoid QRM, the long-running sked. with G2AOK has moved to 70.345 MHz so anyone needing XM60d will find GW3MHW there. John reports that Mike Probert, GW4HFO, in Haverfordwest, using just 20 milliwatts, has worked EI9BG in Co. Clare, and reminds readers that the EIs only have 70.125-70.450 MHz available.

## Two Metres

First the news from overseas. Jesus Suarez, EA1QJ, (VD59h) is now on MS mode from Coruña and between June 28 and July 12 lists completed QSOs with PA3AQM (CL), G3IMV (ZL), DK1PZ (FL), I3TJQ (GF), PA0OOM (DN) and OZ1EKI (EQ). He participated in the big *E*'s opening on July 10 and his list runs to 4½ pages. First QSO was with OK1IDK (GL) at 1521, the last with DF7DF (DL) at 1735. Roughly speaking, the majority of the stations worked were within an approximate 400 kms. radius of the SE corner of EK square, plus OZs in EQ and ER and IS0DKU (EZ). In a tropo. lift on

July 12, Jesus worked G3CHN, G4HFO and GW8VHI and two Fs.

José Gené, EA3LL, (Reus) has been very active on sporadic meteors finding reflections some days better than during many good showers. During July, he worked EI3VDE (VL) on the 4th, G8VJS (ZN) on the 11th, ON5SA (CJ) on the 12th, CT1WW (WB) on the 15th at just 700 kms., G8VR (AL); G4KUX/P (YO) and DF2HC (FN) on the 19th, the last being made during one, long burst of over 30 secs. Up to July 21, tropo. had not been very good and the *E*'s in EA3, generally, was mostly going overhead. However, on July 10, José did work 56 stations between 1506 and 1718 in G, GI, GM, and EI, and some more EIs between 1909 and 1955. On July 19, the EA8s worked into I and YU, and probably into OK in JJ square, a QRB of 3,700-plus kms. Previous *E*'s events this year were:— May 31, 1613-1728 to SV, IT9 and 9H1; June 2, 1720-1730 to SV, YO and YU; June 9, 1521-1703 to II, I7, SV and YU; June 17, 1501-1652 to YO, YU and LZ and June 27 from 1345 to SV1DH and SV1OE.

Eddi Ramm, DK3UZ, (EN20c) had an *E*'s QSO with 4X4OQ (RS55f) on June 7, a QRB of 3,100 kms., and thinks it was a double-hop contact as he was hearing stations as near as JJ square, with many HG, YO and LZ stations copied, too. Eddi was around for the tremendous *Ar* on July 25, but his el-bug decided not to send any dashes. By the time he had found his straight key and a suitable plug, visitors arrived who stayed till 2300 local time. Murphy again!

On the domestic scene, Mike Allmark, (Leeds) noted short *E*'s on July 8 and 9. On the 10th, the proceedings started with a short opening to OE and YU till 1345, the main fun starting to Iberia from 1517 during which most all Spanish squares were heard plus CT4UZ, EA9HW (XV), ZB2BL (XW) and CN8BA (WT24h) whose QSL arrived in three weeks. Mike received Moroccan TV on Band III on this day. During another smaller event on July 15 to I and YU, 9A1FA(?) in San Marino (GD) was heard under local QRM. He was out portable in AN21j from July 25 to 28 for MS in which 65% of the skeds were successful. The team comprised G4HGT, G8MDG and G8MJD and some good tropo. stuff down to northern Spain was also worked. During the *Ar* on the 25th, 15 countries were worked in 70 QSOs including many repeats with MS QSO partners. Finally, in the amazing tropo. opening on July 30/31, all German squares were logged, along with 19 OKs, SPs, Ys, OEs, HGs, OZs, SMs, HB9 and F.

G2AXI added EI3VDE/P (QSL via F6FLV) in Co. Cork; OZ5DD/LX/P and GW8UZL (Gwynedd) on tropo. on July 6/7 while later in the month, the haul included EI9EH (Dublin) and F0GJC/P (YG). The 30/31 affair brought OK, OZ and SM on SSB mode. Syd was on for the

*E*'s on July 10 and on the 15th he worked YU1EN, YU2EZA and YU2IQ from 1440.

G3BW took full advantage of the July 10 *E*'s working 16 EAs, including EA6AU (BZ55a) for a new country. ZB2BL and CN8BA were also new for Bill. Random MS has produced CT1WW (WB); UQ2GFZ (NR) and OE9XXI (EG). Roger Thorn, G3CHN, (Devon) caught some *E*'s on July 9 including YO2IS (KF71a) at 1809; LZ2YC (MD73d) at 1816 and LZ2KSA (MD37a) at 1818. The following day, from 1330, a few OKs and SP9s were netted, but the real big opening to Spain was disappointing. The 15th produced YU7NWN (KF24f) at 1444, then a couple of HGs in KG and some YUs in HF, KE and JD. The *Ar* on the 23rd saw SP2DX (JO43c) at 1737 for best DX in an otherwise local affair, with QTFs at 60° for most of the time. On the 25th, Roger's extensive log shows activity from 1342 to 1830, again with QTFs around the 60° azimuth. Choice contacts include OH2BBF (LT15b) at 1404; I5HBQ (FD25j) at 1436; LZ2KBI/P (LD54c) at 1442 and HG8KAX (KG17g) at 1505. On the tropo. scene, Roger got EI2VDX/P in UL40c and UM70d on July 7 and 9 respectively, while the 14th gave F0GJC/P in YG and, at 2103, a partial QSO with F1DYD/FC in Corsica.

Brian Bower, G3COJ, (Bucks.) mentions some *E*'s on July 15 from 1442 during which he worked Mirko Voznjak, YU1AD (KE13j) whom he met at Leicester last year. Dave Sellars, G3PBV, (Devon) confirms G3CHN's opinion of the super *E*'s event of the 10th in that it was very patchy in the southwest. He did not get in on the July 25th *Ar* till 1700 when the best was over, but reckons he has never heard such loud signals. It faded out at 2000 but came back weakly at 2300. On the MS side, Dave completed on SSB with OZ1EKI (EP) on the 28th. The tropo. opening of the 30/31 July was one of the best he has ever known and produced nine new squares from Scandanavia, including LA1EKO (BQ) in the North Sea. The more easterly DX started to come through at 2330 including OK1AFN/P (IK52a) with a mere 3 watts at 1,406 kms. Apart from the LA, nothing under 1,000 kms. was worked and only real DX seemed to be audible.

John Quarmby, G3XDY, (Ipswich) does not think his QSO with EA8XS (SO73d) on July 10 was complete as Salvador had faded out with him before John could copy his report. However, as some consolation, CT4UZ (VY) was worked at around 2000. John Cleaton, G4GHA (Dorset) added several new squares in YU, YO and OK in *E*'s events on July 9, 10 and 15. Rob Mackean, G4HAO, (Liverpool) lists ZB2BL as his prize QSO at 1955 on the 10th. The *Ar* on the 23rd gave some fairly local stuff but, when Rob switched on at 1450 on the 25th, he could not find a clear frequency

anywhere. 60 stations were contacted between 1500 and 1900, including F6BSJ (CG24f) at 1524 and F1BUU (ZE08c) at 1557.

G4HFO's July 10 *E*'s successes were EA7ABG in Madrid (odd in that YA stations should be EA4); EA5AMR (ZZ); ON6LNV/EA5 (AY); EA3LL (BB) and EA3BRC (BB) all in a 30 minute session. On the 12th, *via* tropo., Martin lists EA1KV (VC67a) with EA1RCA (WD22a) worked on Aug. 2. But his "star prize" was ON1AMR/MM, anchored near Round Island in the Scillies (WK79e) on the yacht *Rebel*. The operator was Ken Ellis, G5KW, who took his 100 watts amplifier along. Your scribe was their 22nd QSO on CW at 2015 when they were on their way back. Ken's key had broken so keying was effected with a crocodile clip, so G3CHN advised later.

Ken Osborne, G4IGO, (Bristol) found some *E*'s on July 9 from 1741 to 1819 and worked YU7NOU, (JE09h); LZ1AB (LC27d); LZ1ZB (LC27a) and YU1EV (KE32g). On the 10th, OK2BFH (JJ) was heard briefly at 1404, the main, Iberian phase lasting from 1503 to 1703 with YA and XB squares worked. Many EA4, 5, 6 and 7's were heard plus EA9HW; CT1WW; CT1ABG (VY); EA6FB (AY) and a snatch of an EA8. In a third phase from 1909 to 2000, Ken got ZB2BL; EA7UH (WX76j) and heard more Y squares. On the 25th, SM6EAN (FR) was worked *via* MS with much noise from the rising sun. The big *Ar* of the 25th was heralded by unlockable Band I TV signals at 1330, the 2m. *Ar* being discovered at 1358. Two distinct QTFs were noted at 40° and 70° and his list includes HG, OE, OK, OZ, SM, SP, Y and F stations with fade out around 2030, returning at 2258 and still going on at 0300 when Ken went QRT. *Via* tropo., F2PC/P (AC30c) was worked on the 27th and EA1CR (XD) on the 29th.

Nick Button, G4IRX, (Beds.) missed all the tropo. DX but had some MS successes. Main activity has been the *E*'s of July 9, 10 and 15, and the *Ar* events of the 23rd and 25th and his log sheets were very neatly set out using different colours for CW and SSB QSOs. 25 new squares came in July for Nick. Graham Taylor, G4JZF, (Staffs.) worked 90 stations in the July 25 *Ar* on SSB, and OK, OZ, Y and SM in the July 30/31 tropo. lift. Jon Stow, G4MCU, (Essex) did not do too much in the big *Ar* as he only had 10 watts available, his amplifier having decided, "... to go on strike!" He, too, found local QRM made it rather difficult for a newcomer to CW mode to get in on the act, however the tropo. on July 30/31 brought in D, OK, OZ, SM and Y QSOs in four new squares.

Those looking for a Scilly Isles QSO should listen for G5KW/A who has an *FDK* 750E and 100 watts amplifier. Ken can often be found on Sunday mornings working G3CHN after Roger has read the *GB2RS* news. Adrian Chamberlain,

ANNUAL VHF/UHF TABLE									
January to December 1981									
Station	FOUR METRES		TWO METRES		70 CENTIMETRES		23 CENTIMETRES		TOTAL Points
	Counties	Countries	Counties	Countries	Counties	Countries	Counties	Countries	
G2AXI	55	8	58	18	43	9	7	1	191
G8FMK	—	—	64	17	54	10	27	2	174
G3BW	34	6	65	27	30	6	5	4	168
GD2HDZ	39	5	60	15	36	9	2	3	164
G8TFI	—	—	63	20	48	14	—	—	145
G8GXE	—	—	52	11	44	9	17	5	138
G8HHI	—	—	49	16	44	12	14	2	137
G3PBV	2	2	56	19	39	8	6	1	129
G8RZP	—	—	62	18	38	10	—	—	128
G8VLQ	—	—	64	16	38	8	—	—	126
G3FLJ	33	5	46	10	27	4	—	—	125
G8RZO	—	—	60	17	31	9	—	—	117
GW3CBY	22	6	50	14	17	6	3	3	115
G8VR	32	3	44	26	6	1	—	—	112
G6ADC	—	—	58	9	33	2	—	—	102
G3FPK	—	—	74	22	—	—	—	—	96
G8WUU	—	—	53	13	23	3	—	—	92
G4JZF	—	—	74	18	—	—	—	—	92
G3CO	14	3	39	8	22	5	—	—	91
G4DEZ	—	—	61	27	—	—	—	—	88
G4FKI	37	5	20	5	16	4	—	—	87
G8KAX	—	—	40	10	20	3	10	3	86
G4HAO	—	—	72	13	—	—	—	—	85
G4ARI	18	2	54	10	—	—	—	—	84
G8WRD	—	—	41	12	21	8	—	—	82
G8VJV	—	—	60	14	—	—	—	—	74
GW8TVX	—	—	49	14	—	—	5	2	70
G4GXL	—	—	51	15	1	1	—	—	68
G8TGM	—	—	48	18	—	—	—	—	66
G8TIN	—	—	40	7	12	3	—	—	62
G8XTJ	—	—	48	9	—	—	—	—	57
G8LXY	—	—	26	5	19	6	—	—	56
GW3MHW	48	8	—	—	—	—	—	—	56
G8RWG	—	—	48	7	—	—	—	—	55
G4LDY	—	—	42	9	2	1	—	—	54
G8RZA	—	—	44	9	—	—	—	—	53
G8SKG	—	—	39	10	2	1	—	—	52
G8TRW	—	—	43	9	—	—	—	—	52
G4MJC	—	—	29	11	5	4	—	—	49
GM4CXP	1	1	25	11	—	—	—	—	38
G6ABB	—	—	32	6	—	—	—	—	38
GM4COK	—	—	21	12	—	—	—	—	33
GM4ELV	—	—	10	3	—	—	—	—	13

Three bands only count for points. Non-scoring band figures in italics.

G6ADC, (Coventry) caught the last half hour of the July 10 *E*'s, heard lots, but failed to crack the pile-ups. He will be G6ADC/W4 for three weeks in October in Florida with a *Trio* TR-2400.

Martyn Jones, G8CXQ, (Warks.) had some nice *E*'s QSOs on July 9, 10 and 15 with CT, EA, HG, I and YU, followed by tropo. QSOs on the 30/31st with D, OK, SM and Y stations. Ray Cox, G8FMK, (Oxon.) had his first ever *Ar* contacts on July 25 with GM3WOJ (YP) and PE1DAB (CN). From the 26th, tropo. conditions steadily improved culminating in D, EI, OK, OZ and SM QSOs at the end of the month. John Pilags, G8HHI, (Hants.) has worked some good GDX in spite of his being away from home a great deal. He mentions the consistent signal from GM6ALC (XQ77e) in Strathclyde, worked on the 18th. The July 30/31 lift brought the, by now, familiar crop of middle and eastern Europeans.

Paul Broadhurst, G8LGL, (Avon) was on the MS trail on July 22 with OZ1EKI (EP) and EA1YY (WD) on the 26th. The tropo. lift of the 30/31st did not come into the Bristol area very well until later on in the morning of the 31st. Paul was one of the few to work ONIAMR/MM in WK

square on Aug. 4. From Cumbria, Sheila Williams, G8KPL, and husband, Dave, G8JAG, were on for the Iberian saga on July 10, best DX being EA5APW (ZY01b) at 1,689 kms. on FM. At one point she was calling Dave on S20, to be answered by another YL operator, EA7AVR, subsequently lost in Spanish QRM.

George Gullis, G8MFJ, (Wilts.) had *E*'s QSOs on July 9, 10 and 15 with LZ, EA and YU folk, plus ZB2BL. On the 14th, F1JG was worked in CD square in 54 mins. *via* SSB MS. George has the call EI3VFF and will be operating -/P from UL square on Sept. 2 and 3; from VL on Sept. 4-6 and from WL on the 8th, on 2m., 70cm., and possibly 23cm. Andy Markham, G8RZA, (Essex) found the July 25 *Ar* "amazing", with the peak at 1400 to 1420. He worked some reasonable DX on SSB with just 25 watts to a 5-ele. *ZL-Special* aerial. He got his first ever OK at 1900 on the 30th and others later. When he went to bed at 0300, OK1MBS (HK) and OK1IDK/P (GJ) were S9-plus-40 dB.

The Brakespears, G8RZO and RZP, have been proving the value of their Isle of Sheppey QTH with some fine tropo. at times when the band was flat for others. 41 stations were worked in the July 25 *Ar*



while tropo. on the 30th brought 26 stations and a further 96 more on 2m. and 70cm., the next day. In the QRP Contest on Aug. 2, 261 stations were worked including GM8MNG/P (YP17h) and DF8LC (FN03a).

Chris Easton, G8TFI, has now moved from Ruislip to a new QTH 750 ft. *a.s.l.* in Gloucestershire which promises to be very good for VHF. He ended with 117 squares including a number of new ones culled in the good tropo. at the end of July. On the 28th, it took 50 mins. to work EA2EG (YC) who insisted on listening for G5s and G7s! Kevin Piper, G8TGM, (W. Sussex) managed some YUs *via E's* on July 9 and 15 in several new squares, and was also QRV in the *Ar* on the 25th and the end-of-month tropo.

Mark Seaman, G8TRW, and John Cooper, G8WUU, certainly struck lucky in their July 25 to Aug. 1 portable expedition to XJ05h in Cornwall. They caught the end of the big *Ar* so missed the "real DX", but continued with MS skeds. The tropo. conditions were very good to the south from the Lizard with EAs in the D squares worked. In all, the various modes produced 14 countries in 68 squares, the gear being an FDK 750E, 160w. PA/preamp. and 16-ele. *Tonna* at 7m. *a.g.l.* All contacts will be confirmed and Mark's address is:— 18 Heycroft Rd., Hawkwell, Hockley, Essex SS5 4HN.

Space really is at a premium this month due to a huge mail bag so the following reports will be rather curtailed.

Colin Bracher, G8WUJ, (Wilts.) is the *real* G8WUJ and the clown using that call in London, calling himself George is a pirate. Welcome to Martin Chapple, G8XQS, (Warks.) who has been on since Sept. 1980 with an *Icom* IC-202S and 25w. amplifier and 9-ele. *Tonna* at 27ft. He has already got 47 squares and 16 countries *via* the recent *E's* and tropo. Derrick Dance, GM4CXP, (Borders) "... came out of hibernation..." in time for the July 10 *E's* when he got some new Spanish squares, but he was away on the 25th, missing the *Ar*, though did manage some tropo. stuff on the 30/31st.

Another new correspondent is Peter Whitburn, GW4EAI, (Gwent) who worked LZ and YU on July 9, 8 EAs and ZB2BL on the 10th, and EA9HG (XV) in a brief *E's* opening on July 30 at 1725 for the first GW/EA9? The *Ar* on the 25th and tropo. on 30/31 provided more, nice DX. The station consists of a *Yaesu* FT-480R, 4CX250B amplifier and a pair of bayed,

9-ele. *Yagis* at 40ft., the QTH being 720ft. *a.s.l.*

The following readers' reports have been read with interest, all having caught most of the big events of the past month:— Neil Clarke, G8VFF; Ken Willis, G8VR; Terry Hackwill, G8WRD; John Fitzgerald, G8XTJ; Darrell Mawhinney, GI4KSO; Geoff Brown, GJ4ICD; Phil Johnson, GJ8KNV; Reg Woolley, GW8VHI and Richard Hope, GW8TVX.

### Seventy Centimetres

The following readers sent in some detailed reports of 70cm. activity in July:— G2AXI, G3BW, G3PBV, G4MCU, G6ADC, G8CXQ, G8FMK, G8HHI, G8LGL, G8RZO, G8RZP, G8TFI, G8TRW, G8WRD, GJ4ICD and GW8VHI. Nearly all were in on the tropo. on July 30/31 and OK1KHI/P (HK) seems to have been worked by the majority.

In the *Ar* on July 25, Angus McKenzie, G3OSS, (London) worked DD8BD (DM); DJ9DL (DL); PA0FRE and G4BPY, who was very strong, and heard G3LQR. The *Doppler* shift was about 2½ kHz high frequency and the SSB signals spread over 4-5 kHz, wider than the passband of normal transceivers, thus making copy that much more difficult. This leads to G8WRD's query as to why everyone gives readability 5 *Ar* reports on SSB mode when usually R4 or R3 would be a more sensible and honest report?

Just in time for VHF NFD, G8TFI completed a *K2RIW* amplifier and a *GASFET* masthead preamplifier is available, so great things are expected from the new QTH at Nympsfield. Chris reckons he will be concentrating on this band in future. G8TRW and G8WUU operated on 70cm. from The Lizard and worked down to ZH, ZE and XD squares as well as southern and central Britain during their brief period in XJ square. They used the FDK 750E and "Expander" with a 15-ele. long *Yagi* loaned by Chris Bartram, G4DGU, of *muTek Technology Ltd.*

### The Gigahertz End

G2AXI only has 1½ watts on 23cm. at the moment so has not done too much DX-ing so far. G3BW is QRP, too, with a 15/15 *Jaybeam* aerial but promises to improve the situation soon. G3PBV now has SSB going from Newton Abbot with about 3w. output to a *D-15* aerial. Feeder loss is 3 dB. with a *muTek* preamp. in the shack. The "prime mover" is a *Yaesu* FT-290R whose 10 memories are programmed

to beacon frequencies. All G8FMK's additions this time were from NFD QSOs which produced 24 contacts and four new counties. During the tropo. lift on July 30, G8HHI worked G3DAH in Kent, using one watt at each end. Although the beacons were up, nothing much was heard by John.

### Tail Pieces

The *Auroral* event of July 25 proved to be the largest and most intense one recorded since 1957. Massive M9 flares and 4B optical ones were recorded and there were *sudden ionospheric disturbances* galore. At the start of the event, the *Meudon A* index reached the incredible level of 125. Will we be reporting a repeat performance on Aug. 2 in the next issue?

As this was being prepared, the *Perseids* shower was reaching its peak. Many were using random SSB on the "new" QRG of 144.4 MHz. At the Brighton Conference, it was decided to promote this *DUBUS* idea proposed last year by F1JG and mentioned in this column last January. To further spread out random operation, it is suggested that the QRG one chooses to call "CQ" should be dependent on the last letter of one's call. So G3FPK would use 144.411 MHz, "K" being the 11th letter of the alphabet, while G8VR would use 144.418 MHz, and so on. This seems a sensible idea in view of the much increased interest in the mode.

### Deadlines

Sorry no Squares Table this month due to pressure on space. All your reports for October by Sept. 2, and for November, by Oct. 7 to:— "VHF Bands", SHORT WAVE MAGAZINE, 34 High Street, WELWYN, Herts. AL6 9EQ. 73 *de* G3FPK.

### STOP PRESS

There was a limited *E's* opening on August 11 around 1830 to about 1920 when CN8BA (WT24h), ZB3BL (XW64g) and several EA7s in southern Spain were worked by a number of readers. At your scribe's QTH, signals were at best S7, but in East Essex and North Kent, they were "end stop", according to G8RZO who telephoned after she and G8RZP had worked ZB2BL.

**For anything radio you want to buy, sell, or exchange, use the Readers' Advertisements columns in "Short Wave Magazine"**

# AN ATTIC BEAM FOR 7 MHZ

## AND SOME AERIALS FOR RESTRICTED SPACE

F. C. SMITH, GW2DDX

**T**HE aerial to be illustrated first, Fig. 1, is in the author's loft, and many amateurs have expressed surprise at the strength of the signal it puts out. Originally, it was put up about seven years ago, and intended for use on twenty metres; it took the form of the well-known W8JK in the variation using end-feed with phasing line, as shown in most of the texts.

The performance on Twenty did not come up to expectations, albeit it did put a signal into W7 and W6 call areas. On 21 MHz the aerial works quite well, with a good beaming effect in the direction of the aerials orientation, namely twenty degrees west of North. A couple of years ago, as Forty was showing signs of something like its old liveliness, the aerial was coupled to the Viceroy and GW2DDX appeared on 7 MHz after a lapse of some years.

The results on Forty were a pleasant surprise; not only did the thing load well, but the signal strengths reported were good — for example S9 + 20 from GM and the North of England, and S8s from east coast stations. A couple of transmissions a week have been made for the last two years and the signal reports have been consistently high.

The horizontal span of the W8JK can be anchored to the lower rafters, or, as in the writer's case, fourteen-foot canes were used with the elements taped to them, run above the rafters — this not only gives greater height, but also gets the aerial further away from the domestic electric wiring; both these of course contribute

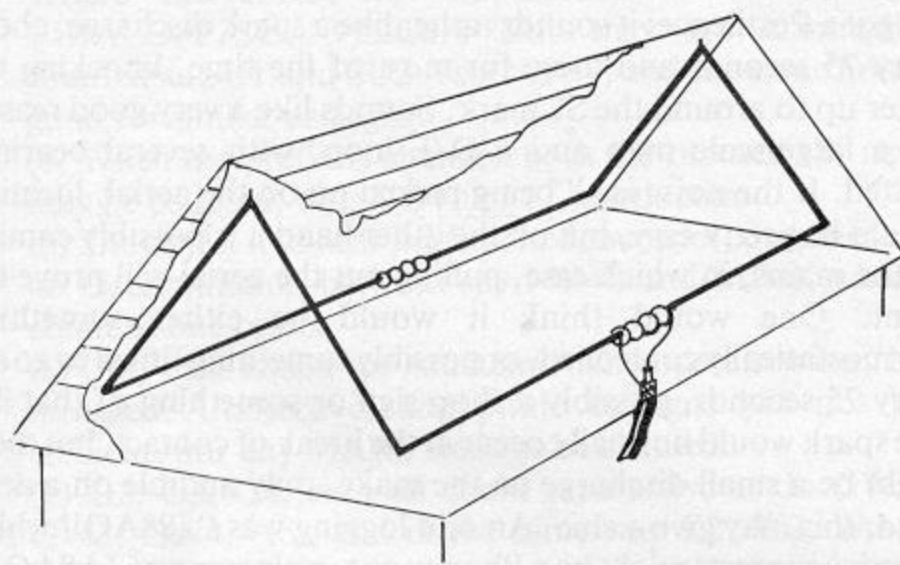

Aerial wire fed over roof rafters

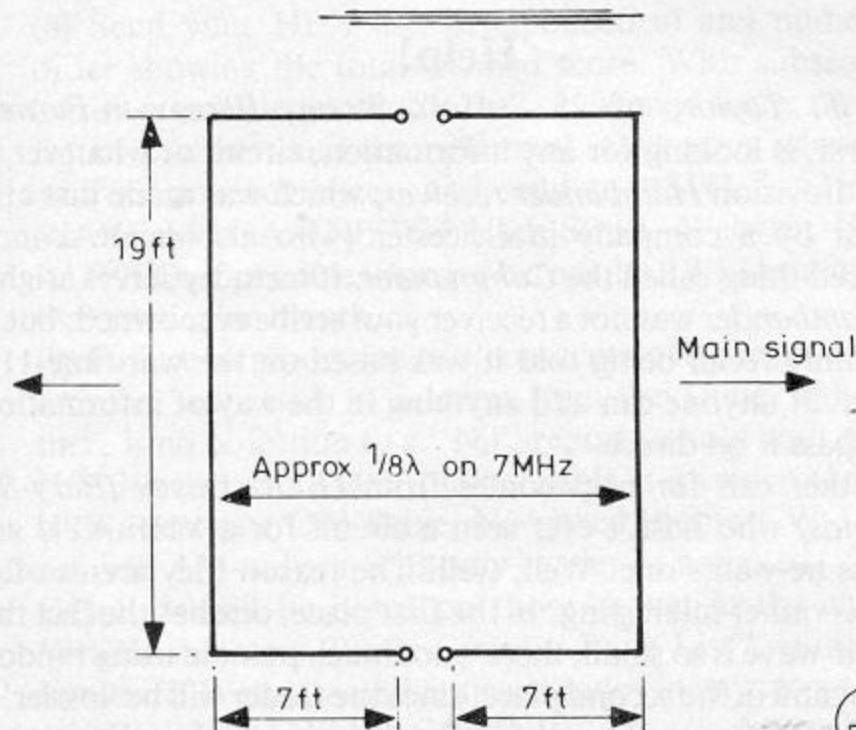

Fig. 1

Plan view

D 703

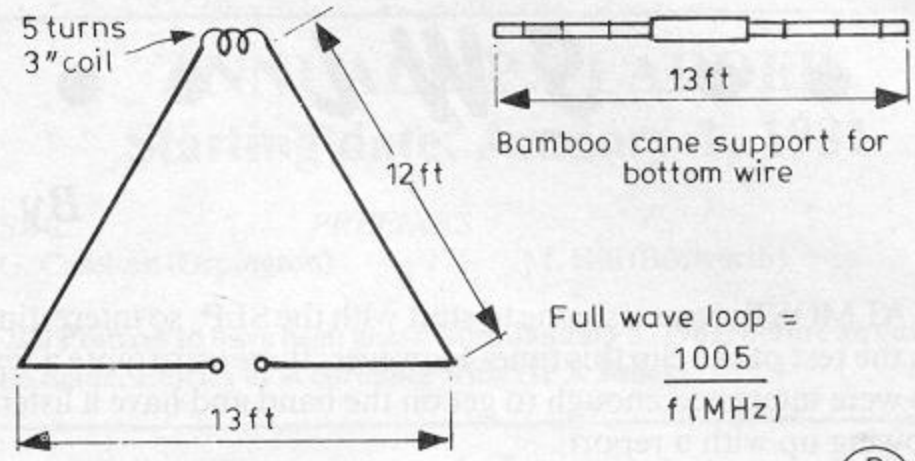

Fig. 2 DELTA FOR 21 MHz

D 704

to improved aerial performance — signal up, noise down!

The ATU for the loft-mounted W8JK consists of a 1½ inch diameter ceramic coil, with 26 turns of 20 s.w.g. wire and a couple of capacitors of about 150 pF, wide spaced, the capacitors being in series with the 72-ohm line feeding the aerial. The coil turns are spaced one wire diameter between turns, and a five-turn link wound on the centre. The writer can say with some confidence that the aerial will perform on Forty as well as, and on occasion better than, the full-sized outside aerial for this band.

Turning now to a Delta Loop, Fig. 2, many people do not seem to realise that one can reduce it in size by coil loading, provided one does not go to extremes. The normal delta loop is a first class DX aerial, but somewhat space-demanding in that a complete element requires a fraction over a full wavelength of wire. However the writer has used quads and deltas for some time, and like most town dwellers is restricted for outside space. Now, 21 MHz is a good DX band, without the vagaries of Ten, and so the writer coil-loaded the ten-metre quad to make it resonant on 21 MHz; this saved some thirteen feet of wire — the sides were twelve feet as compared with a full size 16' 9" for the 21 MHz loop, complete.

A five-turn coil of 3" diameter was fitted in the top of the loop, 'GDO-ed' at the feed point at the base and tweaked to 21.2 MHz. This shorter delta loop was now able to be hoisted quite a bit higher than the full-size example, thus gaining a degree or so of lower angle of radiation, so that the shortened version was getting better reports than the full size job. The reflector, if used, should be fitted with a similar coil, but of six turns and 'GDO-ed' to be five per cent lower in frequency (20.14 MHz — Ed.) which involves an extra twelve inches of wire in the bottom of the reflector loop.

The same tactics can be applied to the quad — after all, quads and delta loops are variations of the same idea — and still put up a worthwhile performance, DX-wise. Thus a ten metre quad, at eight feet a side, can be turned into a shortened fifteen metre one. When shortening elements for coil loading, one must recall there is a limit to how far one can go before the loss of performance outweighs the gain in terms of size. Coils need to be of high 'Q' and constructed to retain their quality in service. In general terms, a little over half the size of the full-sized element seems a good compromise.

In the case of dipoles and parasitic elements, the coils should be placed near the outer limits of the element, instead of the centre (and a capacity hat on the element ends can help here — Ed.). Nonetheless, one will be quite surprised just how good the miniature beam will perform on DX.

Another miniature aerial which has been used by the writer with great success is the Mini-ZL for 14 MHz, which he described in *Short Wave Magazine* for May 1977. These "loaded-whip" aerials are very efficient; for a 14 MHz dipole, the length is only twelve feet and the bandwidth 250 kHz. Thus a dipole for 21 MHz could be eight feet and have a bandwidth of about 375 kHz. The hardest part of the construction is the rather tedious business of winding the elements.

The quad or delta loop can be fashioned from plastic coated electric flex or 16 s.w.g. wire; but for the wound whips, 20 s.w.g. enamelled should be used.

# SWL

## SHORT WAVE LISTENER FEATURE

By Justin Cooper

IT ALMOST seems a shame to start with the SLP, so interesting is the rest of the clip this time! However, there were quite a few who were interested enough to get on the band and have a listen, following up with a report.

Conditions on the chosen date weren't all that wonderful — partly due to summer-type propagation; and, we believe, partly due to lack of activity on the band. This has always been a bit of a problem — people tune round, hear a noise like eggs frying in the distance but no signals, and assume the band to be dead. A CQ under such conditions can be enough to bring a reply from some far-distant place. And, there were other snags, too. . . .

*F. C. D. Barnes (Cardiff)* says he would have liked to have a go, but his homebrew receiver isn't quite up to scratch on Ten — yet!

*Mrs. T. Parry (Blackpool)* and her husband started in to have a quick look, and noted the 5Z4s working G4E00, but then visitors put a stop to activity for the rest of the day.

*A. Rowland (Bude)* writes from his new home; he has an interesting point when he says that it's the first time he's stuck to one band for so long, and it was quite interesting to see how propagation changed steadily as time went on: initially Africa, for about an hour, swinging round to South America later on, with Eastern Europe coming in at the end, and of course the general run of Europeans around all the time. Notable absentees were North America, Eastern Asia, and the usual run of noisy Russian stations. Forty stations were logged on the R-820, all on CW, and none very strong signals.

Next we have *E. Thompson (Basingstoke)* who heard 19 stations on Phone; activity seemed to fall away after a good start, and the SX-28 only heard Europeans towards the later end of the period.

On now to *E. W. Robinson (Bury-St.-Edmunds)*; he used an EA-12 and trap dipole for 14/21/28 MHz for the first nine minutes, and then switched over to the FR-DX400 and its Best Bent Wire. Stations were popping up for a moment and disappearing just as quickly, with fast fading in evidence. Of the 25 QSOs reported on, SWL Robinson showed the hand of the old-timer in the number of contacts where he heard both ends. He also noted some Europeans calling CQ and failing to get a bite.

*D. J. S. Williams (Wednesbury)* was with us in spirit at least — he wasn't going to put off his holiday unless the Customs industrial action scuppered him!

### The Mail

And quite an interesting pile too. First we have to welcome the return of *G. W. Raven (Lewisham)* after a five years lay-off during which there were some three changes of address, before the latest one brought him back to the same district he called 'home' back in 1976. The interest was re-kindled by the sight of someone's CB gear, and so an FRG-7700 was bought and coupled to a Datong AD370 active aerial, and put in the best possible place available (which apparently isn't saying much). However, making the best of things is a fundamental part of our game.

*J. Dooley (Frinton-on-Sea)* enclosed a letter for Mr. Roberts of Cardiff, who was asking about HROs last time out — John makes the rather obvious point that the shocks mentioned could well have occurred through trying to change a coil-set without switching off the 'B+' — we Gs would call it the HT. Something your conductor's weed-infested memory should have recalled, the more so in that we, too, learned the hard way!

Talking of home-brew, we return to *F. C. D. Barnes* who is pondering the matter of his ten-metre coverage as already noted; the possibility of a ten-metre direct-conversion receiver is under consideration. Manufacture of an adequate oscillator would be the prime problem, as any attempt to mix on to the final frequency

would, we suspect, turn out to be an even bigger problem if the spurious responses are to be kept down to an acceptable level.

Which brings us to the letter from *Barry Ward (Nottingham)*. Having been in the R.A.F. and learned Morse, not to mention building various amplifiers, it seemed right to Barry that on taking up SWL, he should build a receiver. The snags lay in that multiple sclerosis had caused early retirement, and he had forgotten about the famous Law attributed to Prof. Jeremiah Sodde, which can be summed up as "you can't win"; and never even heard of Finagle's Axiom, which states that Prof. Sodde's Law is always optimistic. He then goes on to the "Saga of the Six", starting with an attempt at the G3RJV *Direx* receiver, and culminating in the flower of genius that now adorns the bench. This one not only works, but is done *properly* in the style of Messrs. Rolls and Royce. How else could you describe a receiver whose front panel is held to its chassis not only by nuts and bolts but Araldite as well? Then, in order to keep it healthy, it required a diet of incoming signals administered regularly, so an ATU was built — at the second try it worked quite nicely. Next the headphones disintegrated, to be replaced by a pair contrived from a set of dead Akai hi-fi ones and a couple of hi-impedance earpieces. Then of course came the aerials: all have to go up while feet remain aground, for obvious reasons, but there is copper in the sky and down below, with a CW HPX list to prove it. A veritable breath of fresh air and good humour in our mail — let's hear more!

Next we come to *H. M. Graham (Chesham)*, who notes that during the whole period no North American signals were heard on Ten, although the band was often open into Africa and South America, and hence of course the nearer parts of Asia — all of which are more or less North-South. On a different tack, Maurice has got a Pestilence; it sounds rather like a spark discharge, about every 75 seconds and there for most of the time, knocking the meter up to around the S7 mark. Sounds like a very good reason for a large-scale map and a D/F loop, with several bearings plotted. If the noise is all being picked up on the aerial, location should be pretty easy, but on the other hand it is possibly coming up the mains, in which case, pulling out the aerial will prove the point. One would think it would be either something thermostatically controlled, or possibly something timed to go off every 75 seconds, possibly a shop sign or something of that ilk. The spark would normally occur at the break of contact, but there might be a small discharge on the make, only audible on a dead band; this may give a clue. An odd logging was "J88AQ" which Maurice suggests might be a Phoney or a mislogging of JA8AQ — we incline to the latter view.

### Help!

*M. T. Taylor*, of 25 Suffolk Street, *Barrow-in-Furness*, Cumbria, is looking for any information, circuit or whatever on the Radiovision *Hambander* receiver, which was made just after the war by a company in Leicester (who also made a more advanced thing called the *Commander*, if memory serves aright). The *Hambander* was not a receiver your scribe ever owned, but he does dimly recall being told it was based on the war-time 1155 receiver. If anyone can add anything in the way of information, please pass it on direct.

Another call for help comes from *G. A. Davey (Bury-St.-Edmunds)* who hasn't ever seen a circuit for a VHF ATU and reckons he wants one. Well, well! The reason they aren't often found is rather interesting. In the first place, one has the fact that as a half-wave is so small, there's not much point in using random lengths; and in the second place, since the feeder will be 'lossier' at VHF those losses will tend to make the mis-match seen at the rig smaller, and about all one needs to do is tweak the front-end and

PA stages to give maximum urge up the spout. As for using an HF aerial at VHF, it is hardly ever a success; even if one can get power into it, it will be horribly directive and, so That Law says, in the wrong direction!

We now come to a letter from *S. H. Clark (Great Barr)*, who has been talking to local G3RJV and been convinced that he can build himself a receiver. So — now come the questions, and the first one is this: how to make layout and wiring diagrams from the circuit? The advent of the semi-conductor and the printed board (or, for that matter *Veroboard*) has changed things a little but in principle the scheme remains. Take a piece of paper, and make templets of all the various bits that live above the chassis, and likewise for the underside. Juggle the templets around until you get a good looking layout, sketch it in, do the same for the underneath, and then hold them up to the light and see there are no "fouls" which could upset the appletart (variable capacitors, for instance, need fixings!). Put the papers to one side, and re-use the templets for another try, forgetting as far as you can the original one. Compromise is usually required as most layouts have bad points. Eventually, decide which of the ones tried looks best, and from that draw out the wiring. If one has some printed board, one can cut, with a 'junior' hacksaw, through the copper in parallel lines both ways, so that you end up with a lot of copper squares; and if you have been careful your board is still a board

### HPX RULES

- (1) The object is to hear and log as many *prefixes* as possible; a prefix can only count once for any list, whatever band it is heard on.
- (2) The /M and /MM suffixes create a new series: thus G3SWM, G3SWM/M and G3SWM/MM all count as prefixes, and where it is known to be legal, /AM also.
- (3) Where a suffix determines a *location* the suffix shall be the deciding factor, thus W1ZZZ/W4 counts as W4. Where the suffix has no number attached, e.g. VE1AED/P/SU, VE2UJ/P/SU, they are arbitrarily counted as SU1 and SU2 respectively, and the same holds good for similar call signs.
- (4) When the prefix is changed both the old and the new may be counted; thus VQ4 and 5Z4 both count.
- (5) The object is to hear *prefixes* not countries, thus there is no discrimination between say MP4B and MP4K which count as one prefix.
- (6) Only calls issued for Amateur Radio operation may be included. Undercover and pirate call signs will not be credited, nor any MARS stations be claimed.
- (7) G2, G3, G4, etc., all count separately, as do GW2, GW3, GW4, etc., and in the same way K2, W2, WA2, WB2, WC2, WN2, all count separately even though they may be in the same street.
- (8) Send your HPX list, in alphabetical and numerical order showing the total claimed score. With subsequent lists, it is sufficient to quote the last claimed score, the new list of prefixes, and the new total. Give your name and address on each sheet, and send to "SWL", SHORT WAVE MAGAZINE, 34 High Street, Welwyn, Herts. AL6 9EQ, if possible to arrive before the SWL deadline for that particular month.
- (9) Failure to report for two consecutive listings, i.e. four months, will result in deletion from the Table, although there is no objection to a "Nil" report to hold your place.
- (10) Starting score 200. Phone Table is mixed AM/SSB, with a separate CW Table. No mixed Phone/CW Table, nor will AM-only or SSB-only entries be accepted.
- (11) Lists will be based on those shown in the current "Radio Amateur Prefix-Country-Zone List", published by Geoff. Watts (see Advertiser's Index in any recent issue of SHORT WAVE MAGAZINE).

## ANNUAL HPX LADDER

### Starting date, January 1, 1981

SWL	PREFIXES	
G. Caselton (Orpington)	271	M. Hill (Bedworth) 207

200 Prefixes to have been heard since January 1, 1981, before an entry can be made. Entries in accordance with HPX Rules.

and not bits! If it is double-sided, the whole of the other side can be used as the earth plane, just drilling through for components to go direct to ground. However, *don't* use double-sided board for the oscillator, or you'll have a drift problem.

The second question is about RF amplifiers, and in connection with such designs, given a good front-end the answer is "don't" — the extra gain will only serve to reduce the dynamic range. If you must add some gain, add it *after* conversion. Finally, ATUs: and here we have to say that a personal point of view is to avoid such as the pi-network type like the plague — they are fine for transmitters where one can peak them up, but as they are essentially low-pass filter sections J. C. finds them hard to peak on receive; our preference is for an ordinary tuned circuit, organised to hit the band with about 1.5 pF per metre wavelength as judged by eye and grid-dipper, and then to croc-clip the aerial and the receiver connection to the coil, with the earth connected to the bottom of the parallel tuned-circuit, until you get it right. If you have a bandswitch of six pole, three-way construction, you can solder your connections to this as you find the right spots for each band — the third wafer merely serving to short-out more of the coil as you go to the higher bands. One can be made for 1.8-14 MHz, and a second for 21/28 MHz if "the best" is required. And, of course, if the aerials are going to be dipoles, one hardly needs an ATU anyway.

*D. J. S. Williams (Wednesbury)* has had more time for listening of late, but the only DX heard was Fiji which wasn't a new one anyway! However, he has a job sorted out with Plessey at Romsey, which will give him plenty to think about as well as a new QTH and aerials to change the radio view a little.

*M. Cuckoo (Herne Bay)* hasn't had much time for SWL this time round; he was on for about a half-hour during the SLP, and heard the same signals as most others on at that time, noting that all signals had the very deep fading on them.

We have just a very brief note from *M. Law (Chesterfield)* who adds some American and Russian prefixes to his total.

Next we come to *Mrs. R. Smith (Nuneaton)* who has been surprised by the present of an FRG-7700 receiver with its matching ATU; plus, in effect, a new shack in the dining-room and a revamp of the aerials which was in progress as she wrote to meet the deadline. Now she will be well occupied for a while "unlearning" the old receiving techniques — a fair old jump from an AR88 to the new receiver, and different aerials as well, which will give a different aspect to master, not to mention the extra time available having the rig where it can be used between other activities.

*J. F. Hobson (Ely)* has been enjoying summer activities (sheltering from the rain?) and a total house re-decoration too, which cut him down on time a bit, but he has four new ones — of VK9XA (Cocos-Keeling) he says "Been there; there's not much to see!" That seems to give us the chance to ask whether that is right, or should it be Keeling Cocos? The latter is the name used by Eric and Susan Hiscock in their books, while the former appears in our *Bartholomew* atlas.

*B. Henderson (Laverstock)* has been taking our advice last time to heart and spending time gardening, plus some RAE study along with junior op. — apparently the course was so large it had to be split in two!

## HPX LADDER (All Time Post War)

SWL	PREFIXES	
PHONE ONLY		
K. Kyezor (Brandon)	2656	D. J. S. Williams
B. Hughes (Worcester)	2334	(Wednesbury) 903
S. Foster (Lincoln)	2111	B. A. Payne (Leeds) 885
E. W. Robinson		F. C. D. Barnes (Cardiff) 867
(Bury St. Edmunds)	1894	D. J. F. Gordon
M. J. Quintin		(Chepstow) 833
(Wotton-u-Edge)	1517	P. Eggeman (Borehamwood) 774
Mrs. R. Smith (Nuneaton)	1514	J. M. Short (Thornbury) 729
H. A. Londesborough		J. A. Darby (London SE16) 715
(Swanland)	1498	B. L. Henderson (Laverstock) 673
M. Cuckoo (Herne Bay)	1378	R. Baker (North Walsham) 590
H. M. Graham (Chesham)	1367	A. Stevens (Crowthorne) 589
M. Rodgers (Harwood)	1280	M. N. W. Thornton
M. Law (Chesterfield)	1206	(Romford) 579
G. W. Raven (London SE13)	1161	Mrs. T. Parry (Blackpool) 521
J. Worthing (Shrewsbury)	1157	P. J. Boyce (Stoke) 502
P. Ford (Longlevens)	1128	
N. Askew (Coventry)	1042	<b>CW ONLY</b>
G. A. Davey		H. A. Londesborough
(Bury St. Edmunds)	1027	(Swanland) 1294
J. F. Hobson (Ely)	1023	D. W. Waddell (Herne Bay) 1257
R. Middleton		J. Goodrick (Bognor Regis) 842
(Bury St. Edmunds)	1022	A. Rowland (Mansfield) 524
D. C. Casson (Reading)	957	E. B. Ward (Ruddington) 468
J. Doughty (Bloxwich)	915	J. M. Dunnett (Prestatyn) 442
L. Stockwell (Grays)	908	N. I. Neame (Lancing) 438

Minimum Score for entry: 200 for CW, 500 for Phone. Listings include only recent claims and are in accordance with HPX Rules. A 'Nil' return is permissible in order to hold a place.

### Vale

From the Welwyn office your scribe has heard of the death of Briant Shepherd of Staines; unfortunately we don't have any details. We shall miss his distinctive handwriting and sometimes memorable phrases set in always-interesting letters.

### Retirement

Our old friend *K. Kyezor (Brandon)* writes to say that with the current list he proposes to bow out of the HPX Ladder — the last time someone retired it was generally reckoned that "the mark" was 1000, and K.K. has gone up to 2656, no less. Your conductor has been writing this piece for upwards of fifteen years, and finds it hard to recall not seeing a letter first from Perivale then Irchester, and more recently Brandon; and he spans a SWL career of some 58 years. Other interests we recall as the arts and crafts embodied in the generic description of "model engineering", and in particular live steam models. We hope that, having given up prefix-hunting, K.K. will keep on listening, and we hope very much that he will be able to drop a line occasionally and let us know how he is getting along.

### New

A first entry from *G. Caselton (Orpington)* using a BC-348R and an inverted-vee; his main interest is in 14 MHz. He makes an opportune comment on what the future may well hold, when he recounts what happened when he puts up a two-metre collinear

aerial at the front of the house: there were two complaints of TVI, one of which resulted in a visit from the Post Office interference chaps wanting to know where the CB rig was hidden away. They were somewhat upset to find only an SWL station. Perhaps we should have expected this to happen sooner or later, and we wonder how many similar cases have gone without mention.

*N. I. Neame (Lancing)* uses CW and is ex-G2AUB. Nigel seems to have added to his troubles by collecting a slipped disc — horizontal for a while, and at the time of his letter up and about but wearing a suitable brace.

Normally, the acquisition of the full ticket signals the end of contribution to "SWL" but *B. Payne (Leeds)*, who is now G6AEZ (congratulations, Brian!) is, it seems, using the HPX Ladder as an incentive to get that Morse sorted out, and who are we to argue about such a valuable aid?

*M. Rodgers (Harwood)* has just a list this time — but the steady progress of the Rodgers score up the ATPW list talks for him, come to think of it.

### New Thought

*P. Lincoln (Aldershot)* is prematurely retired on health grounds, and like so many in this predicament, Peter finds amateur radio a valuable hobby. He runs an Eddystone 1570 receiver, which he has fitted with a 2 kHz mechanical filter, a noise blanker, and an NBFM demodulator. This receiver, incidentally, is one of the new generation of Eddystone gear, and Peter has it coupled to a Microwave Modules MM2000 and a Datong FL2 to enable him to take RTTY quite effectively. His question is a simple one, namely — could he include an RTTY/Phone combined list? One would feel that RTTY is hardly a good mix with either CW or Phone, but we wouldn't have any great objection to adding an RTTY-only classification, on the same basis as the CW listing in terms of starting score, if there is any interest. Peter himself is well on the way with some seventy RTTY prefixes already scored.

*M. N. W. Thornton (Romford)* has had to put in a Nil return this time, domestic activities having had to take priority for the moment.

Like the others who took part in the SLP, *E. W. Robinson* seems to have enjoyed himself well enough, even though he didn't find any new prefixes. The period under review was overall somewhat sparse in the matter of new ones, but as he says — no contests to bring 'em out!

*Mrs. T. Parry*, as we have already said, couldn't do much in the SLP; and she is finding things a little more demanding now — the promised youngster arrived some five weeks ahead of schedule, but at least he waited until the 500 prefixes came up. Congratulations and good luck.

*E. Thompson (Basingstoke)* is having his interest in HF diluted somewhat by listening on VHF, so as to know what it's all about up there for when the 'B' licence is obtained as a result of, hopefully, a pass in the December RAE. Edmund wants to know a bit more about the HPX Ladder — and the answer to that is a reprint of the Rules this time, which should answer the questions.

Finally, we note *A. Rowland* seems to be settling in to the new place in Cornwall, and notes a certain spark of interest in the hobby from his XYL, so he'll maybe have some quite local competition!

### Wind-up

Time once again for the farewells, the deadline for next time round will be *September 17*, to arrive, and as always addressed to your J.C., "SWL", SHORT WAVE MAGAZINE, 34 High Street, Welwyn, Herts. AL6 9EQ. Till then, mind how you go!

October issue due to appear on Friday, September 25th.

## COURSES FOR THE R.A.E., 1981-82

**Bath:** Details of evening classes starting in September may be obtained from the tutor, Peter Bubb, G3UWJ, 58 Greenacres, Bath BA1 4NR. (Tel: 0225-27467).

**Belfast:** College of Technology (GI2BX), College Square East, Belfast, commencing Sept. 15, Tuesdays 5.30-8.30 p.m. (Theory and Practical), Thursdays 6.8 p.m. (Morse), enrolment early Sept. Further details from lecturer, J. E. Wilson, at the above address.

**Birkenhead:** North Wirral C of T, Borough Road, Birkenhead, Wirral, enrolment Sept. 7/8/9. Full details from the Senior Lecturer, D. E. Owen, G4GGB, Dept. of Electrical Engineering. (Tel: 051-653 5555, ext. 230).

**Borehamwood:** De Havilland College, Elstree Way, Borehamwood, Herts. (01-953 6024), Mondays 7-9 p.m., commencing Sept. 28, enrolment 2-8 p.m. Sept 14/15. Lecturer G. L. Benbow, G3HB.

**Bracknell:** Bracknell College, Dept. of Engineering and Science, Church Road, Bracknell, commencing Sept. 28, enrolment Sept. 10/11/14, course tutor G8KIL.

**Canterbury:** Canterbury C of T, Canterbury, Kent, Monday evenings, tutor G3LCK. Full details from the college.

**Dudley:** Dudley C of T, The Broadway, Dudley, West Midlands, Tuesdays 6.30-8.30 p.m., enrolment Sept. 8. Lecturer J. Raby, G8RF.

**Durham:** New College, Durham, commencing Sept., details from J. Greenwood, G3ZJY, QTHR (0385-66773).

**Farnborough:** Oak Farm Community Centre, Chaucer Road, Farnborough, Hants, Thursdays 7.30 p.m., commencing Sept., tutor J. Hardy, G3KND. Details from the Warden at the above address (Tel: Farnborough 515045).

**Hemel Hempstead:** Dacorum College, Marlowes, Hemel Hempstead, Wednesdays 6.30-9.00 p.m., starting Sept. 23, enrolment Sept. 7. Further details from course organiser, C. Burke, G3VOZ (Hemel Hempstead 833300).

**Kettering:** Latimer Adult Education Centre, Castle Way, Barton Seagrave, Kettering, enrolment 7-8.30 p.m. Sept. 7/8, course fee £11.07 for 24 weeks, postal enrolment from Sept. 9 (cheques payable to "Northants County Council").

**Leamington Spa:** Mid-Warks. College of F.E., Warwick New Road, Leamington Spa, Thursday evenings starting Sept. 17, enrolment Sept. 3/4 9-12 a.m., 2-4 p.m., or 6-8 p.m.

**London (Chingford):** Friday Hill House, Simmons Lane, Chingford, London E.4, commencing Sept. 17, Thursdays 7.15-9.45 p.m., enrolment on first night at 7.15 p.m. Enquiries to tutor Alan Foss, G8EAY, 01-529 3380.

**London (Harrow):** Hatch End High School, Headstone Lane, Harrow, Wednesdays 7-10 p.m. starting Sept. 30, register at Nower Hill School Sept. 19. Course includes Morse. Tutor D. T. Busby, G4HFL.

**London (Holloway):** Holloway Institute, Mondays 6.30-9.30 p.m., starting Sept. 21, enrolment week commencing Sept. 14. Further details from lecturer, B. C. Bond, G3ZKE, 01-485 7065.

**London (Paddington):** Amberly Road Evening Institute, Amberly Road, Paddington, Mondays and Thursdays 7-9 p.m., starting Sept. 28, enrolment Sept. 8/9/10 or Sept. 14/15/16. Course includes Morse. Tutor D. T. Busby, G4HFL.

**Loughborough:** Loughborough Technical College, Radmoor, Loughborough, Leics., Tuesdays 6-7 p.m. (Morse) and 7-9 p.m. (Theory and Regulations), commencing Sept. 15, course fee £15.05. Tutor D. Doughty, G3FLS.

**Manchester (Swinton):** Pendlebury High School, Cromwell Road, Swinton, Thursdays at 7.30 p.m., commencing Oct. 1, registration during week beginning Sept. 14. Details from course instructor, P. Whatmough, G4HYE, 061-794 3706.

**Melton Mowbray:** Melton Mowbray College of F.E., Asfordby Road, Melton Mowbray, enrolment Sept. 8. Further details from the College or course tutor K. Melton, G3WKM (Melton Mowbray 68810).

**Newcastle-upon-Tyne:** Gosforth Adult Association, Gosforth Secondary School, Gosforth, Newcastle-upon-Tyne, Tuesdays 7-9 p.m. starting in Sept. Course tutor D. R. Loveday, G3FPE, Enquiries to The Principal at the above address, or ring Newcastle-upon-Tyne 668439.

**Northampton:** Duston Upper School, Tuesdays at 7 p.m. starting Sept. 8. Full details from the lecturer B. Steen, G8LHR, 0604-499067.

**Oxford:** Oxford College of F.E., Oxpens Road, Oxford, Tuesdays 6.30-9 p.m. commencing Sept. 22, enrolment Sept. 3, 3-7 p.m. or Sept. 7, 2-4 p.m., course fee £30 plus exam fees.

**Rawtenstall:** Accrington and Rossendale College, Haslingden Road, Rawtenstall, Tuesdays (probably) 7-9 p.m. beginning week commencing Sept. 7, enrolment Sept. 2/3, 2-4 p.m. and 6-8.30 p.m. Full details from teacher D. Haworth, G4IFT, at the College (Tel: Rossendale 213558).

**Slough:** Langley College of F.E., Station Road, Langley, Slough, Thursdays 5.30-7 p.m. (Operating Techniques, on the air with the college station, G3XPL) and 7-8.30 (Morse), Wednesdays 7-9 p.m. (Theory), enrolment Sept. 8/9 12.30-8 p.m. Contact Senior Lecturer, E. C. Palmer G3FVC, for further details.

**Stockton-on-Tees:** Stockton-Billingham Technical College, Oxbridge Avenue, Stockton-on-Tees, Mondays 6.30-9 p.m. starting Sept. 21. If there are sufficient numbers a second course will be held on Tuesdays 6.30-9 p.m. Thursdays 7-9 p.m. (Morse) starting Sept. 24. For further details contact J. Ross (Tel: 0642-552101 work, or 0642-64974 home).

**Walsall:** Queen Mary's Grammar School (Broadway North Adult Centre), Walsall, enrolment in Sept., fee £10. A short course (10 weeks) is also being held starting in Sept. at Barr Beacon School, Walsall (fee £4), for those who wish to re-take the exam. Full details from the tutor, F. Fear, G8CVR, 185 Longwood Road, Aldridge, West Midlands. (Tel: Aldridge 52706).

**Welwyn Garden City:** De Havilland College, Applecroft Centre, Applecroft Road, W.G.C., Thursdays 7-9 p.m. starting Oct. 1, enrolment Sept. 14/15, 2-8 p.m. at De Havilland College, The Campus, W.G.C. (Tel: W.G.C. 26318 or 31344).

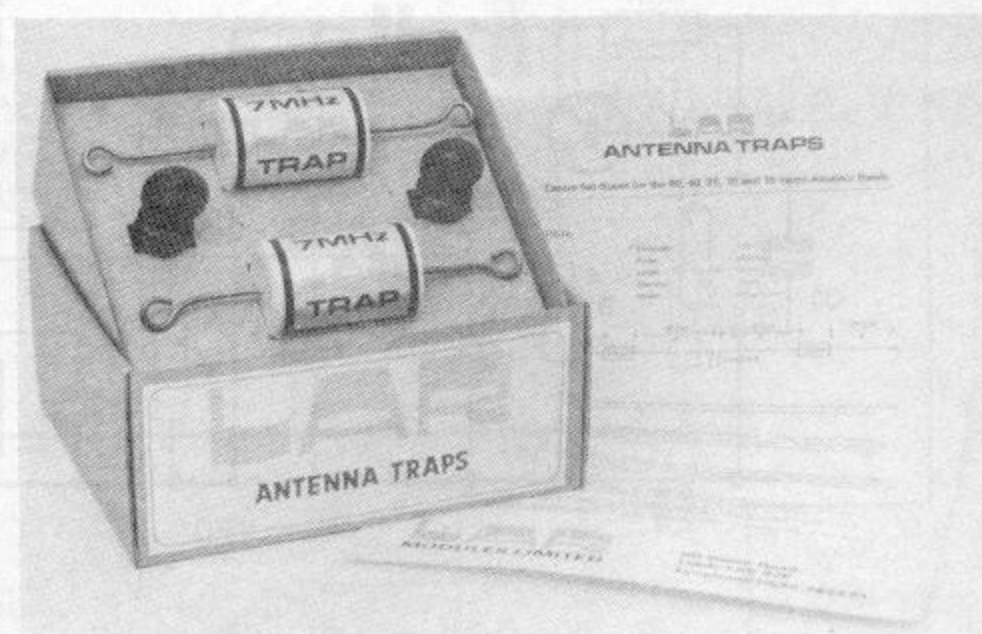

This attractively boxed pair of 7 MHz weather-proof traps (500-watt rating) comes from LAR Modules Ltd., 60 Green Road, Leeds LS6 4JP. Included in the package are a pair of lightweight end insulators and full instructions for making a 5-band trap dipole. The price inclusive of VAT and post/packing is £14.25.

# CIRCUIT OPERATION AND ALIGNMENT OF THE FRG-7 RECEIVER, PART I

INCLUDING A SIMPLIFIED ANALYSIS OF THE OPERATION OF THE DRIFT-CANCELLING BARLOW-WADLEY LOOP

J. L. LINSLEY HOOD, MIEE, MIMC

**T**HE Yaesu Musen FRG-7 remains one of the most popular of the medium price range general coverage communications receivers, and its general method of operation is typical of a number of similar receivers based on the drift-cancelling oscillator arrangement known as the Barlow-Wadley loop. However, I have

noted, with some regret, that those of my friends and acquaintances who own receivers of this type tend to regard them as 'black boxes' whose insides are both complex and sacrosanct, and view the possibility of an improvement in their alignment — should circumstances suggest that this might be useful — as an undertaking only to be attempted by the foolhardy or the extraordinarily well equipped.

I feel that this is a pity for several reasons. Firstly because I think that a good understanding of the way in which a piece of equipment works can help to increase one's enjoyment in its use; secondly, because without that understanding, and some minimum items of essential equipment which might be borrowed for the occasion, it would be quite unwise to poke about inside such an instrument; and thirdly because the accurate alignment of a receiver of this type, even with the appropriate equipment, is a job which will, inevitably, take several hours — so, on the production line, it is not going to be done as accurately, in every case, as one might wish. Finally, there are several things which can be done to improve the usefulness of such a receiver, ranging from the fitting of an external frequency counter, either of commercial origin or a DIY design, of which several have been described recently, to an improvement in the IF selectivity. None of these

741a

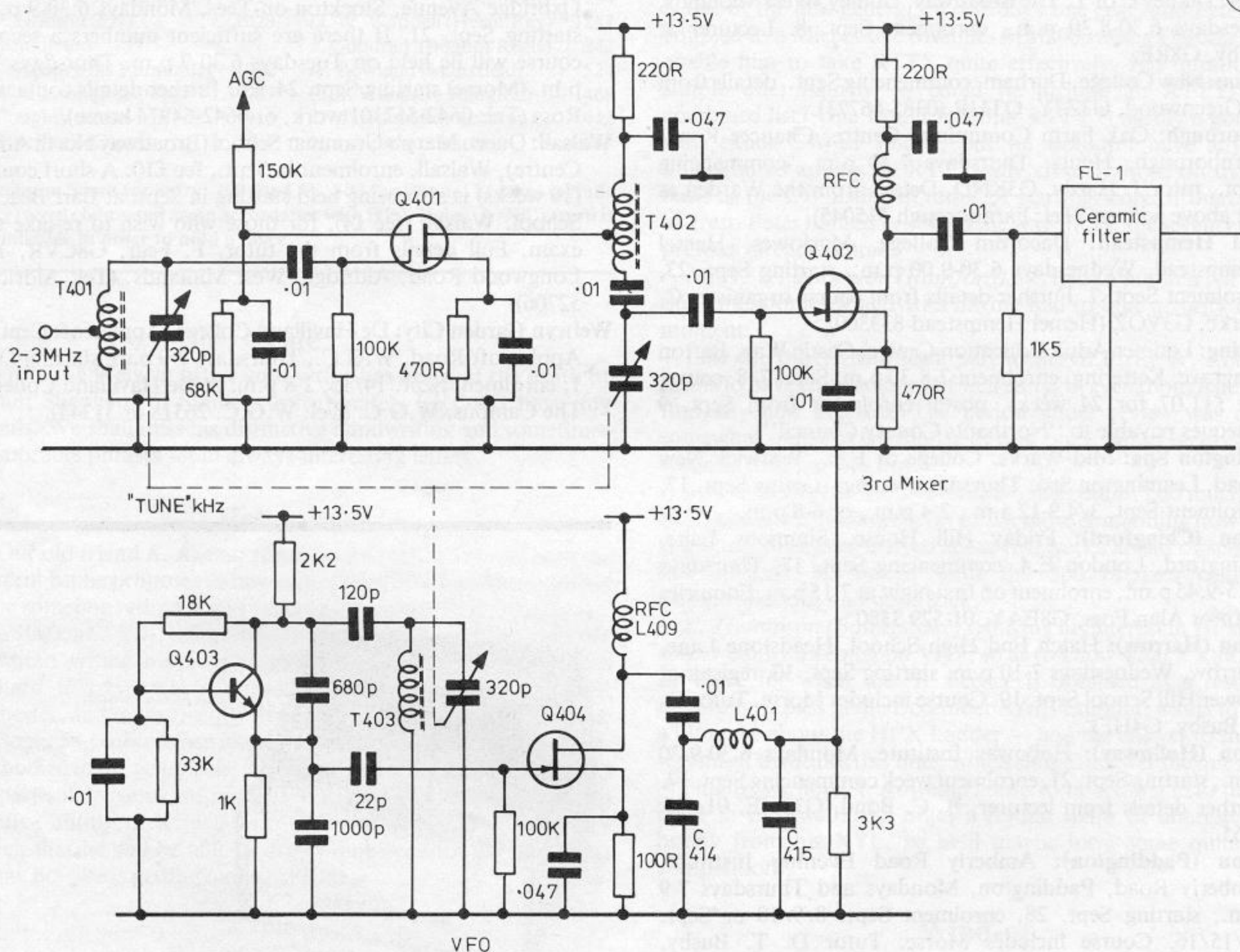

Fig.1 THE "kHz" TUNED STAGE OF THE F.R.G.7. (Second and third IF's and audio output)

things can be done with ease or confidence if the circuit operation is not clearly understood.

### Circuit Operation

In the owner's manual, the makers describe the FRG-7 as a triple conversion superhet, using a synthesised heterodyne oscillator. Although the subsequent circuit description is both accurate and concise, it does not add much to the bare bones of that initial description, nor does it encourage the owner to take the circuit diagram in hand and make a conducted tour through the design. This omission I hope to remedy.

To begin with, I think it is helpful to regard this receiver as two separate parts. These are a conventional superhet, with one RF stage and two 455 kHz IF stages, covering the frequency range 2-3 MHz, and a preceding double-conversion RF unit, in which a 1 MHz wide slab of signals is converted up in frequency from the incoming 'aerial' frequency to the band 54.5-55.5 MHz, and then down again to the 2-3 MHz pass band to which the second half of the receiver is tuned. The double conversion, upwards and downwards in frequency, allows the drift cancelling feature of the Barlow-Wadley loop, but it does carry a penalty, which will be considered later. Since the second part of the receiver is the easiest

part to follow, and the one in which the user may wish to make mods., I propose to take this bit first.

The general layout of the circuit is shown in Fig. 1, in a simplified form, but with the component numbers used by Yaesu appended where appropriate. This uses a dual-gate MOSFET, Q401, as the RF stage, a junction FET, Q402, as the frequency changer, and a bipolar transistor, Q403 as the tuned oscillator stage. The oscillator is followed by a junction FET buffer, Q404, which is used to inject the oscillator signal into the source of the FET mixer, Q402. A low-pass filter, L409, C414, C415 and L401, is used to remove any second harmonic from the output of the oscillator, which might give rise to spurious signals.

The first 455 kHz IF stage, Q405 is shunt fed from the mixer through a ceramic filter, FL-1, with a pass-band of about  $\pm 4$  kHz at  $-10$ dB, in the interests of obtaining the selectivity required as far forward in the circuit as possible, to minimise cross modulation. The two 455 kHz IF stages, Q405, Q406, are conventional, neutralised, bipolar transistor tuned amplifier stages, with a choice of demodulators fed from Q406.

For normal AM reception, a diode detector, D402, is fed directly from the collector of Q406, although a peak-limiter diode, D407, may be switched into circuit for automatic impulse

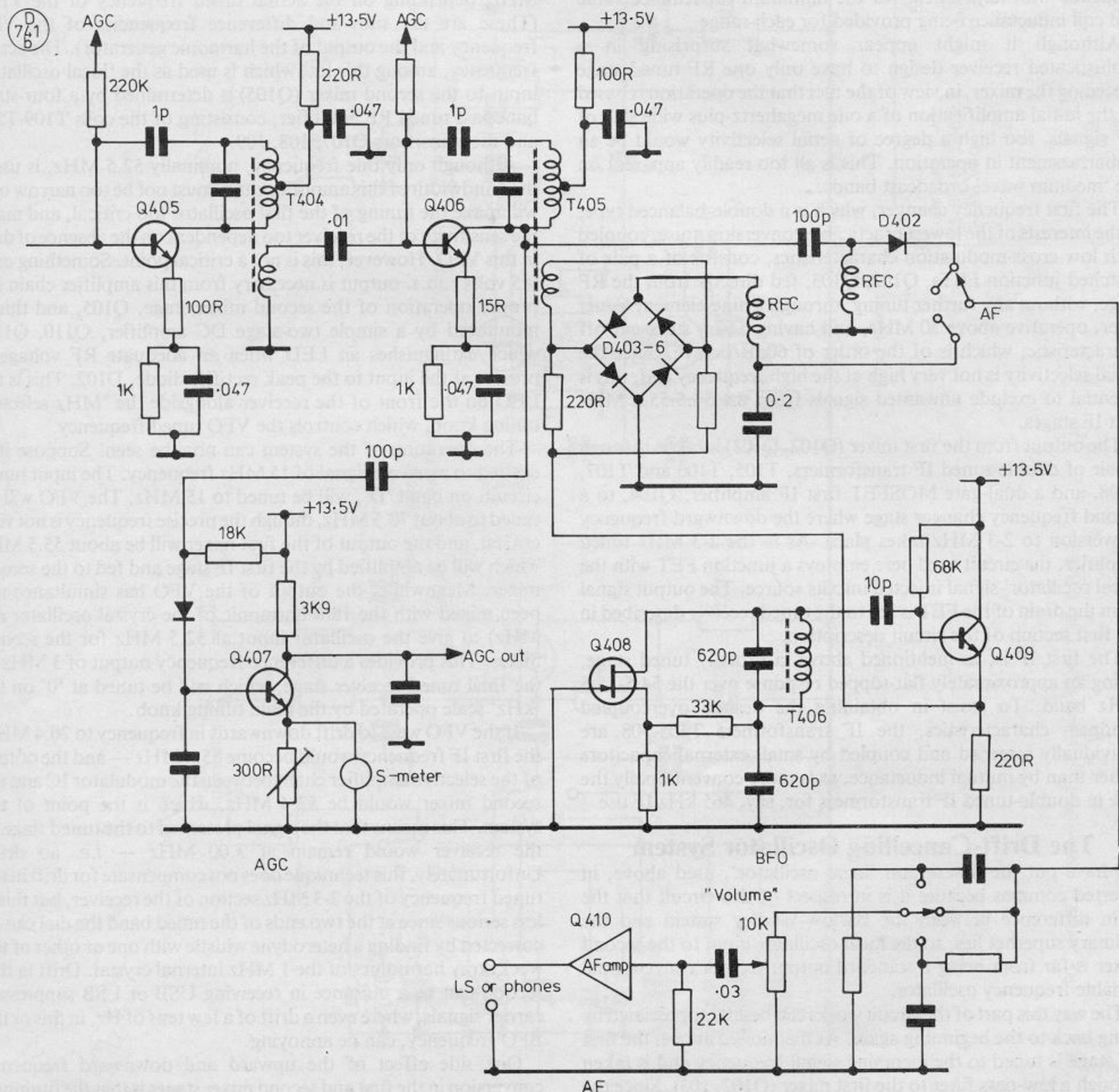



# WATERS & STANTON ELECTRONICS

18/20 MAIN ROAD, HOCKLEY, ESSEX. Tel: (0702) 206835

## INTRODUCING AZDEN PCS 3000



ONLY £219

## STOP PRESS

THE ANNUAL AMATEUR RADIO RETAILERS ASSOCIATION EXHIBITION HAS BEEN MOVED FROM LEICESTER TO CASTLE DONINGTON (ADJACENT M1)  
DATES: — 29, 30, 31 OCTOBER

At last here is a fully synthesised 2m FM mobile rig with full band scan and eight channel memory — AT A SENSIBLE PRICE! The fabulous AZDEN PCS 3000 is a new 25 watt transceiver which combines the latest technology inside with an easy to use exterior.

★ The front 2½ inches is completely detachable and with the optional extra cable kit, the main unit can even be mounted in the boot! YOU NEED NEVER BE AFRAID TO LEAVE YOUR CAR IN THE CAR PARK AGAIN!

The control head fits easily into your briefcase, jacket pocket — even the wife's handbag!

- ★ Full 144-146MHz coverage in 25kHz steps or 12½ kHz option.
- ★ Computer controlled touchpad for frequency selection.
- ★ Multi function microphone gives up/down tuning and memory recall.
- ★ Repeater shift and tone burst.
- ★ Complete with mobile bracket, microphone and leads.
- ★ Control buttons back lit.

### GLOBAL ACCESSORIES

**INTERFERENCE?**  
**HP4A FILTER**  
NO MORE TVI FROM CB OR AMATEURS  
The HP4A provides a highly effective solution to TVI and simply connects to any UHF TV receiver.  
Global HP4A  
£5.95 Post free.

**BRAND NEW ITEM**  
**Global PS-15**  
Power Supply Unit  
12-15v.  
5.2A (5.8 max.)  
with volts/amps meter  
Price t.b.a.

**SHORTWAVE LISTENER**  
**A.T.U.**  
**GLOBAL AT1000**  
£31.95  
carriage free  
The ultimate in ATU's, specially designed to enhance the performance of all short wave receivers — no other model can approach its performance.

### ARE YOU THINKING OF TAKING THE RADIO AMATEURS EXAM?

There's only one way to learn procedure — Listen in!

£89 inc. VAT + delivery.

#### FDK TM56B



The TM56B is a highly sensitive VHF monitor receiver for listening to the popular 2 metre FM transmissions from radio hams throughout the U.K. Hear your local amateurs transmitting from their cars, from home, or through one of the many repeaters sited around the country. 230v AC or 12v DC operation is possible, and a built-in auto-scan circuit monitors 4 priority channels. The receiver is supplied with the ten most popular channels fitted. Extra channels are available at £3 each.

**SPECIAL OFFER**

WITH EVERY TM56B ORDERED THIS MONTH WE WILL SEND YOU A COPY OF THE AMATEUR RADIO EXAMINATION MANUAL — FREE!

MONDAY—SATURDAY 9-5.30

WATERS & STANTON ELECTRONICS

EARLY CLOSING WED 1.00 p.m.

WARREN HOUSE, 18/20 MAIN ROAD, HOCKLEY, ESSEX

Telephone (0702) 206835/204965

Telex 897406

PHONE ORDERS

ACCESS

BARCLAYCARD

MAIL ORDER

RETAIL CALLERS

MAIL ORDER SLIP to: Waters & Stanton Electronics, Warren House, Main Road, Hockley, Essex. "Such Friendly People"

Name . . . . . Goods required . . . . .

Address . . . . .

Please rush me the above. Cheque enclosed for £ . . . . .

Please charge to credit card No. . . . .

noise reduction. However, for suppressed carrier USB or LSB operation an FET oscillator, bipolar buffer combination, Q408, Q409, can be switched into use. In this case the audio signal is taken from the output of the 'ring modulator' which consists of the diodes D403-406.

A normal integrated circuit AF amplifier, Q410, is fed from the demodulator selector switch *via* a very simple high-pass/low-pass filter switch and the volume control VR1. This will operate either an internal or external LS or phones.

HT supplies for the receiver are provided from batteries, external or internal, or from a mains power supply using a very simple, single transistor, series stabiliser, Q411. Amplified AGC is obtained from a single transistor, Q407, also fed from the collector of Q406. This is arranged to provide a DC signal which becomes progressively more positive as the IF signal strength decreases. The signal strength meter is also fed from this stage, but with a signal voltage which falls as the IF output diminishes.

### RF, Mixer, and Input Double-Conversion Stages

A simplified circuit diagram for this section is shown in Fig. 2. As in the 2-3 MHz section of the receiver, a dual-gate MOSFET, Q101, is used as the RF stage. Four switched tuned circuits on the input to this provide an initial selection of the input signals, in the range 0.5-30 MHz. These are tuned by a single gang, 300pF, capacitor with adjustment for the minimum capacitance value and coil inductance being provided for each range.

Although it might appear somewhat surprising in a sophisticated receiver design to have only one RF tuned stage preceding the mixer, in view of the fact that the operation is based on the initial amplification of a one megahertz-plus wide slab of RF signals, too high a degree of aerial selectivity would be an embarrassment in operation. This is all too readily apparent on the 'medium wave' broadcast bands.

The first frequency changer, which is a double-balanced type, in the interests of the lowest practicable conversion noise, coupled with low cross-modulation characteristics, consists of a pair of matched junction FETs, Q102, Q103, fed directly from the RF stage, without any further tuning, through a nine-element Cauer filter, operative above 30 MHz, and having a very steep cut-off characteristic, which is of the order of 60dB/octave. Since the aerial selectivity is not very high at the high frequency end, this is essential to exclude unwanted signals from the 54.5-55.5 MHz first IF stages.

The output from the first mixer (Q102, Q103) is taken through a pair of double tuned IF transformers, T105, T106 and T107, T108, and a dual-gate MOSFET first IF amplifier, Q104, to a second frequency changer stage where the downward frequency conversion to 2-3 MHz takes place. As in the 2-3 MHz tuned amplifier, the circuit used here employs a junction FET with the 'local oscillator' signal injected into its source. The output signal from the drain of the FET is fed to the tuned receiver described in the first section of the circuit description.

The first IF is, as mentioned above, a broadly tuned stage, giving an approximately flat-topped response over the 54.5-55.5 MHz band. To assist in obtaining the desired overcoupled bandpass characteristics, the IF transformers T105-108 are individually screened and coupled by small external capacitors rather than by mutual inductance, as is more conventionally the case in double-tuned IF transformers for, say, 465 kHz IF use.

### The Drift-Cancelling Oscillator System

I have put the description 'local oscillator', used above, in inverted commas because it is in respect of this circuit that the main difference between the Barlow-Wadley system and the ordinary superhet lies, so the local oscillator input to the second mixer is far from being a standard output from a conventional variable frequency oscillator.

The way this part of the circuit works can best be appreciated by going back to the beginning again. As mentioned above, the first RF stage is tuned to the incoming signal frequency and is taken through a low-pass filter to the first mixer (Q102, 103). Since the

input frequency coverage is, nominally, 0.5-30 MHz and the first IF is centred on 55 MHz, the local oscillator frequency for the first mixer needs to cover the frequency range 55.5-85 MHz. This can be done conveniently, on a single sweep, using a 60pF variable capacitor, VC201, using a single transistor, Q201, and a single coil, T201, in a grounded-base Colpitts oscillator circuit. A simplified circuit is shown in Fig. 3.

To minimise loading on the oscillator circuit, a small secondary winding is used to pick off the oscillator output voltage to feed to the first mixer (Q102, 103). However, this is where the drift cancelling system begins, because the output from the first VFO is also taken to a double-balanced modulator IC, a Texas Instruments SN76514 (Q106), where it is mixed with the output from a crystal oscillator harmonic generator. The understanding of the operation of this is the key to the comprehension of the receiver system as a whole. Fortunately, it isn't too difficult.

The first part of this is a straightforward, 1 MHz crystal oscillator, built around a single transistor, Q301. This feeds a twin diode squarer circuit, D301, D302, which feeds the modulator IC through another steep-cut LC low-pass filter, L303-1 L303-4, which has a sharp cut-off above about 33 MHz. This generates a slab of harmonics from 2-32 MHz which are mixed with the output of the local oscillator to give an output, at pin 3 of the SN76514 IC, containing frequencies ranging from 23.5 to 117.5 MHz, depending on the actual tuned frequency of the VFO. (These are the sum and difference frequencies of the VFO frequency and the output of the harmonic generator). The actual frequency, among this lot, which is used as the 'local oscillator' input to the second mixer (Q105) is determined by a four-stage bandpass tuned RF amplifier, consisting of the coils T109-T116 and the transistors Q107, 108, 109.

Although only one frequency, nominally 52.5 MHz, is used, the bandwidth of this amplifier chain must not be too narrow or it will make the tuning of the first oscillator too critical, and make the sensitivity of the receiver too dependent on the absence of drift in this VFO. However, this is not a critical point. Something over 0.5 volts r.m.s. output is necessary from this amplifier chain for proper operation of the second mixer stage, Q105, and this is monitored by a simple two-stage DC amplifier, Q110, Q111, which extinguishes an LED when an adequate RF voltage is present at the input to the peak rectifier diode, D102. This is the LED on the front of the receiver alongside the 'MHz selector' tuning knob, which controls the VFO tuned frequency.

The operation of the system can now be seen. Suppose it is desired to receive a signal of 15 MHz frequency. The input tuned circuit, on band 'D', will be tuned to 15 MHz. The VFO will be tuned to about 70.5 MHz, though the precise frequency is not very critical, and the output of the first mixer will be about 55.5 MHz which will be amplified by the first IF stage and fed to the second mixer. Meanwhile, the output of the VFO has simultaneously been mixed with the 18th harmonic of the crystal oscillator (18 MHz) to give the oscillator input at 52.5 MHz for the second mixer. This provides a difference frequency output of 3 MHz to the final tuned receiver stage, which will be tuned at '0' on the 'kHz' scale operated by the main tuning knob.

If the VFO were to drift downwards in frequency to 70.4 MHz, the first IF frequency would become 55.4 MHz — and the output of the selective amplifier chain between the modulator IC and the second mixer would be 52.4 MHz, which is the point of the system. This means that the signal presented to the tuned stage of the receiver would remain at 3.00 MHz — *i.e.* no drift. Unfortunately, this technique does not compensate for drift in the tuned frequency of the 2-3 MHz section of the receiver, but this is less serious since at the two ends of the tuned band the dial can be corrected by finding a heterodyne whistle with one or other of the weak stray harmonics of the 1 MHz internal crystal. Drift in this section can be a nuisance in receiving USB or LSB suppressed carrier signals, where even a drift of a few tens of Hz, in this or the BFO frequency, can be annoying.

One side effect of the upward and downward frequency conversion in the first and second mixer stages is that the tuning of

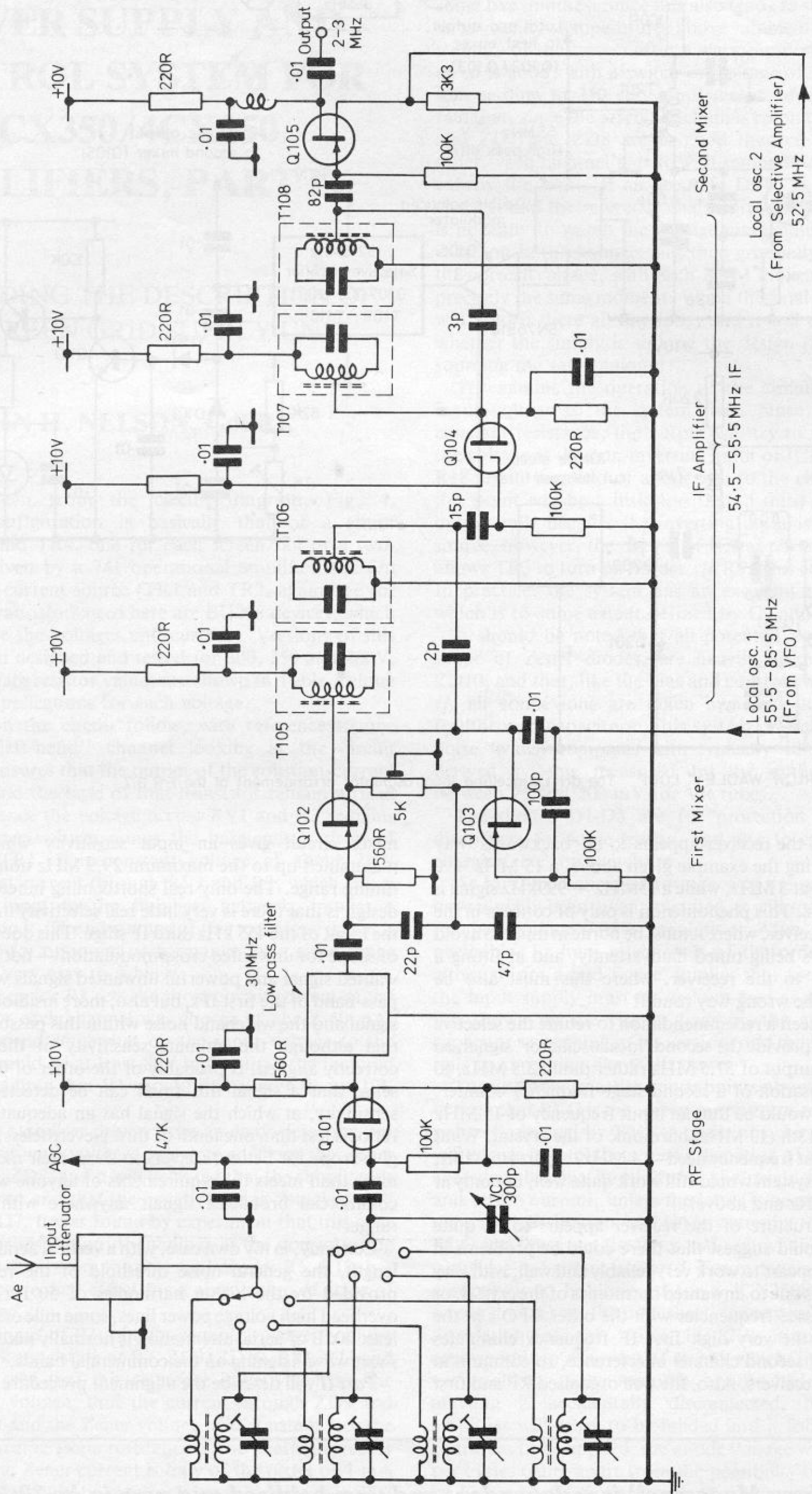

Fig. 2 RF MIXER AND FIRST IF STAGE OF THE F.R.G.7

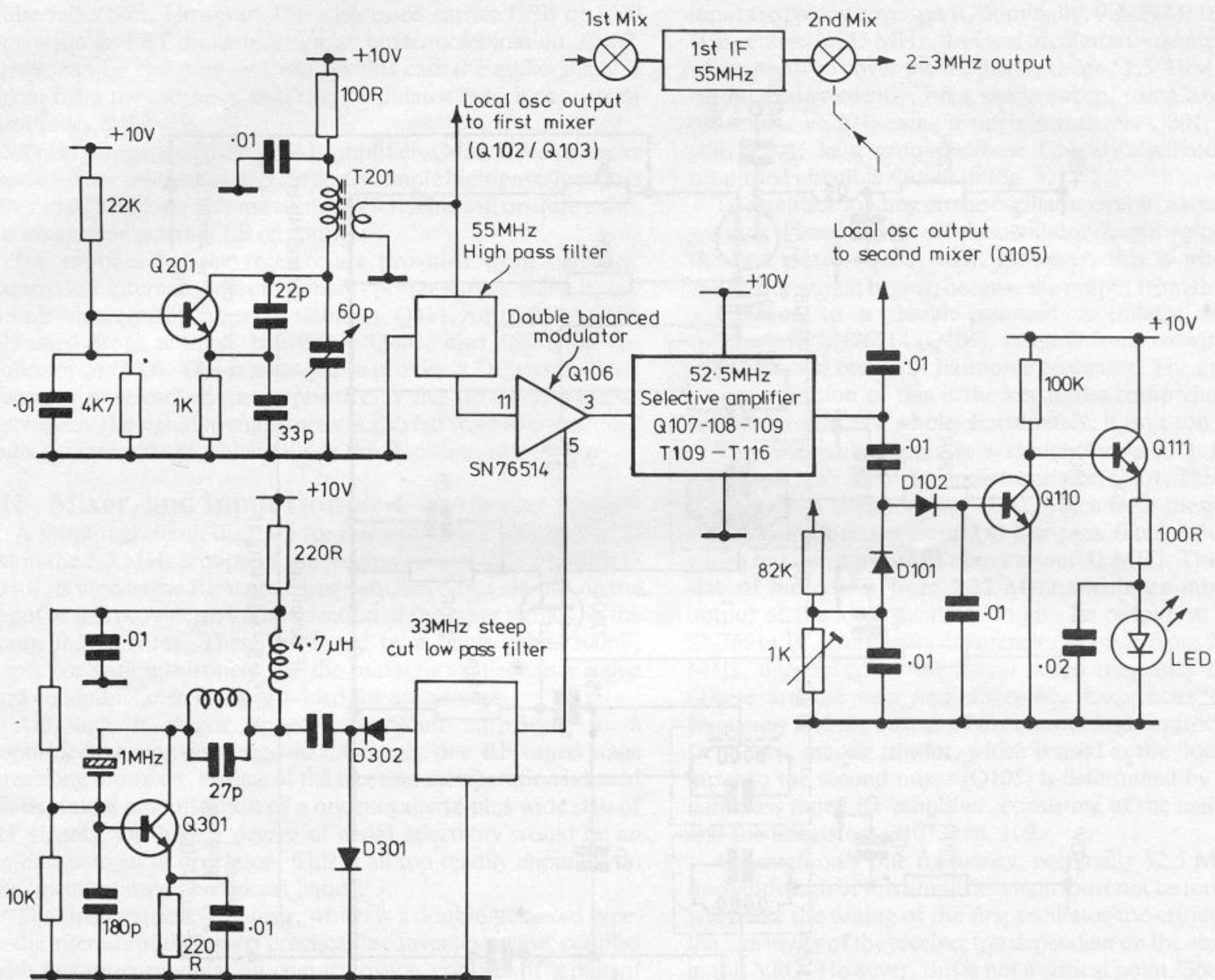

Fig. 3 THE 'BARLOW-WADLEY' LOOP The drift cancelling local oscillator arrangement of the F.R.G.7

the tuned stages of the receiver appears to be 'backwards' way round, so that, taking the example given above, a 15 MHz + 0 kHz signal is tuned at 3 MHz, while a 15MHz + 999kHz signal is tuned at 2.001 MHz. This phenomenon is only of concern in the alignment of the receiver, where it must be borne in mind to avoid the wrong trimmers being tuned inadvertently, and in fitting a frequency counter to the receiver, where this must also be organised to read the wrong way round!

I have, I regret, seen a recommendation to retune the selective tuned stages which provide the second 'local oscillator' signal, so that these give an output of 57.5 MHz rather than 52.5 MHz, to simplify the organisation of a second stage frequency counter. The snag with this would be that an input frequency of 15 MHz would require the 13th (13 MHz) harmonic of the crystal. What would a 1 MHz input frequency need — 1 MHz? Apart from this, the drift cancelling system would still work quite well, but only at frequencies of 3 MHz and above!

Although the structure of the receiver appears to be quite complex, which would suggest that there could be problems in use, in practice it appears to work very reliably and well, with very few spurious signals due to unwanted harmonics of the crystal, or its sum and difference frequencies with the other VFO's in the circuit. Certainly, the very high first IF frequency eliminates entirely the pest of second channel interference, so common in earlier short wave receivers. Also, the well organised RF and first

mixer circuit gives an input sensitivity which is very well maintained up to the maximum 29.9 MHz nominal limit of the tuning range. The only real shortcoming inherent in the circuit design is that there is very little real selectivity in the circuit up to the input of the 455 kHz third IF stage. This does allow quite a bit of scope for unwanted cross-modulation — not only between the wanted signal and powerful unwanted signals within the 1 MHz pass-band of the first IFs, but also, more insidiously, between the signal and the wideband noise within this passband. This means that although the ultimate sensitivity of the receiver, when correctly aligned, is probably of the order of 0.02  $\mu$ V — in the sense that a signal this small can be detected — the usable sensitivity, at which the signal has an adequate signal to noise ratio, is less than one tenth of this. Nevertheless, although it does give scope for better receivers to show their merit, in practice it more than meets the requirements of anyone wishing to receive commercial broadcast signals anywhere within its frequency range.

Certainly, in my own case, with a vertical aerial of about 15 feet length, the general noise threshold of the receiver is mostly provided by the higher harmonics of 50 Hz radiated by the overhead high voltage power lines, some mile or two away, and at least 20dB of aerial attenuation is normally necessary for general short wave listening on the commercial bands.

Part II will describe the alignment procedure for the receiver.

# A HIGH-PERFORMANCE POWER SUPPLY AND CONTROL SYSTEM FOR 4CX350/4CX250 AMPLIFIERS, PART IV

## CONCLUDING THE DESCRIPTION OF THE SCREEN GRID SUPPLY UNIT

JOHN H. NELSON, G4FRX

IT will be seen from the circuit diagram, Fig. 4, that the configuration is basically that of a shunt stabiliser (TR3 and TR4, one for each screen rail of a two-valve design) driven by a 741 operational amplifier and fed from a constant-current source (TR1 and TR2, again one for each rail). The transistors used here are BU208 devices, which will easily handle the voltages and currents. Versions of this system have been designed and tested for 300, 350 and 400V, and the appropriate resistor values are shown in Table 1 along with suggested applications for each voltage.

Some notes on the circuit follow, with reference to one channel (the "left-hand" channel looking at the circuit diagram). ZD1 ensures that the output of the constant-current generator TR1 and the base of that transistor remain a fixed voltage apart; hence the voltage across RV1 and R3 remains fixed at the Zener voltage minus the base-emitter drop of about 0.7V in TR1. This constant voltage of about 2.6V implies a constant current through RV1 and R3, which, since this forms the input to the stabiliser network, implies a constant current to it. The advantage of this technique is that it makes setting-up for optimum performance for a given range of input voltage very easy to achieve.

The value chosen for R1 sets the short-circuit current of the system, which for each channel was chosen as about 50 mA. Its value will depend somewhat on the input voltage to the system, which should be at least 80V higher than the required output; this will imply that R1 should be between about 10K and 20K.

TR3 is a shunt stabiliser driven from an error-detecting op-amp IC1. The op-amp voltages are derived from the Zener chain ZD3, ZD4, ZD7, and it will be noted that the supply rails are some 30V apart and that the negative rail is "stacked up" by 75V due to ZD7. It was found by experiment that this gave much better error resolution: the voltage at the non-inverting input of IC1, obtained from the potential divider R6, R18, has a much greater correcting effect for a given value of error of the output voltage.

The inverting input of IC1 obtains a stable voltage from the reference network consisting of R7, ZD9, ZD10, R12, R13 and RV3. It will be seen that this reference is derived from the stabilised output voltage: thus the current through ZD9 and ZD10 is constant and the Zener voltage held constant (see the notes above regarding slope resistance!) The heating effect is also low, since the Zener current is only of the order of 1 mA for each device. It should be mentioned at this point that ZD7 and ZD8 are 20W devices and are mounted close together on the chassis for good thermal coupling. They are arranged to

run quite warm, and in fact their temperature when mounted on the "FRX standard box" stabilises at about 55°C after some five minutes. Since this also tends to stabilise ZD9 and 10 at a steady temperature above ambient, the temperature stability of the system after a warm-up period of five minutes or so is good, with a switch on voltage of 346 in the author's unit settling to 350 very consistently. More important is the fact that, since the reference chain is common to both channels and ZD7 and ZD8 are in good thermal contact with each other, each channel's drift with temperature, such as it is, is exactly the same. If an accurate DVM is connected to each channel and the reference chain sprayed with freezer spray, it is uncanny to watch the voltage immediately fall to the same value on both channels and then gradually come back up to the correct voltage, with each DVM indicating the increase at precisely the same moment. When the final value is reached, it will hold it there all day long; and it will do so regardless of whether the supply is sinking the design figure of 20 mA or sourcing the same amount.

To examine the operation of the circuit, assume that the input voltage to the system rises. Since TR1 looks like a constant resistance, the output will try to rise; consequently, the voltage at the non-inverting input of IC1 also rises. R6 and R18 are in the ratio of about 5:2, so the change of voltage at this point will be a little less than a third of its value at the output rail. Because the inverting input is fed from a stable source, however, the output of IC1 at pin 6 will also rise. This allows TR3 to turn on harder *via* R5, thus correcting the error. In practice, the system has an excellent transient response, which is to some extent defined by C9 and C10.

It should be noted that all potential noise sources, in the shape of Zener diodes, are heavily decoupled, particularly ZD10, and that, like the bias and control system in *Parts I* and *II*, all connexions are taken into and out of the box *via* feedthrough capacitors. This system produces about 3 mV of noise, which compares with typically 40-70 mV for Zener-derived systems measured by the author and anywhere between 25 and 200 mV for VR tubes.

The diodes D1-D8 are for protection in case a supply disappears for some reason, and also to cater for capacitors charging, etc, on switch-on.

As for the practical performance of the system, some details have already been given; as stated, it will source or sink 20 mA for better than 0.08% regulation. After warm-up, drift is negligible. Its hum rejection is of the order of 30dB which, although not a bad figure, implies that for best performance the input supply must be as hum-free as possible. Although not shown on the circuit diagram, the author uses choke-capacitor smoothing in his version, and the hum on the output rails is something like 90dB down.

Turning now to other minor points about this circuit, it will be seen that RLG is the screen overcurrent relay, and its pull-in point is adjusted by RV5. A judicious choice of value for R1 will ensure that (a) the screen dissipation of the valve cannot be exceeded, bearing in mind that the product of screen voltage and screen current, unless the latter is negative, approximates the screen dissipation, and (b) any attempt to do so will actuate RLG and thus reset the timer and remove the anode and screen supplies – see circuit in *Part I*. For instance, let us assume that a supply is to be designed for a 4CX250B with 300V on its screen grid. From the data sheet, we remember that the screen dissipation of this valve is 12W maximum. Now this corresponds to a current of 40 mA which, in normal service, is very unlikely to be remotely approached: if, however, the antenna is accidentally disconnected, for example, the amplifier will cease to be loaded and it follows that, if drive continues to be applied, the anode voltage will fall to zero once per cycle. Quite apart from the possibility of damage induced by heavy back-bombardment, it follows that the screen grid will act as though it were an anode and thus it will try to draw a good deal more than 40 mA. This is why an overcurrent relay

**Table of Values**  
**Fig. 4.**

R1, R2 = see text	ZD3 to ZD6 = 15v.
R3, R4 = 47R	ZD7, ZD8 = 75v.
R5 to R11 = see Table 1	ZD9 = 24v.
R12 to R15 = 27K	ZD10 = 82v.
R16, R17 = 5K6	D1 to D8 = 1N4006
R18, R19 = see Table 1	D9, D10 = 1N5406
RV1, RV2 = 200R preset	D11 = 1N4148
RV3, RV4 = 20K, 15-turn	TR1 to TR4 = BU208
RV5 = 500R preset	IC1, IC2 = 741CN
C1, C2, C5, C6 = 47 $\mu$ F, 63v.	VDR1, VDR2 = see text
C3, C8, C14, C16 = 1nF cer.	T1 = see below
C4, C15 = 4n7 cer.	LP1 = as required
C7 = 22 $\mu$ F, 100v.	RLG = 24v. DPCO
C9 to C12 = 22 pF poly.	S1, S2 = SPCO
C13 = 100 $\mu$ F, 500v.	FS1 = 250 mA a/s
ZD1, ZD2 = 3.3v.	FS2 = 100 mA

Note: ZD7 and ZD8 are 20W, *i.e.* BZY93C or CR; the rest are 500 mW, *i.e.* BZY88, OAZ247, 1S7000 series. T1 should be chosen so that input voltage to supply is at least 80v. greater than required screen supply voltage. Feedthrough capacitors as required, provided working voltage adequate.

is so important, and also why the power supply itself must be designed so as not to aid and abet the screen grid's delusions of anodehood! For the author's unit, R1 and R2 were made 18K so that, with an input to the system of 440V for 350V output, the short-circuit current is just under 50 mA. This is about the right figure, since at 40 mA the output voltage of the rail is down to about 90V (implying 3.6W), and even so RLG will have operated by then so there is a "belt-and-braces" effect in this part of the circuit.

Note that, as recommended in the earlier article, the screen grids are earthed on "receive" by RLD1 and RLD2, and that S1 and S2 form "run/set" switches as used in the G4AJW design. This enables the standing current in each valve to be easily adjusted by means of varying the screen voltage of either valve *via* RV3 and RV4 and, with component values as shown, these have a control range of approximately 15V. This is more than enough to ensure very accurate balance between and pair of reasonably good valves.

Finally, VDR1 and VDR2 are worthy of some comment. Since transistors are intolerant of high-voltage spikes such as could be induced, for example, by valve flashover, it was deemed necessary to provide some protection for them. In fact, as will be seen when the EHT System is described, the approach adopted is also "belt-and-braces" since the EHT supply is itself current-limited and also arranged to "crowbar" the screen supply lines in much the same fashion as in the G4AJW design. However, since there was some doubt about the response time of the protection system, it was decided to add voltage-dependent resistors across the output of each screen rail in the supply to form a fast-acting "clamp" device. The components used, in fact, were three 425V devices, since each is theoretically capable of dissipating a single pulse of 10 joules; some back-of-an-envelope calculations showed that, assuming a worst-case response time for the EHT system's protection circuit to operate, three VDRs would cope adequately with the surge voltage and current, thus protecting the BU208s, until the system could turn itself safely off. (At the time of writing, it has not been possible to determine how much work the VDRs are doing in the event of a flashover, since the protection circuit itself appears to be much faster-acting than was thought might be the case. However, during the course of some five months of assorted abuse, both simulated and real, no transistors have yet failed). Unfortunately, no data seems to be available on the response

time of VDRs to overvoltage under operating conditions such as these, and it appears to be extremely difficult to measure. Anyhow, as stated, nothing has blown up yet!

## Construction

That concludes the electronic considerations involved in this system, and we may now examine practical realisation of it. The prototypes were built on a printed-circuit board mounted in a standard 170 x 120 x 55mm die-cast box, and the photographs should give a good general idea of the result. The BU208 transistors for the 300V version of the system can be mounted on the box itself, as seen in the photograph of this unit, and they replace the centre rows of feedthrough capacitors visible in the picture of the 350V system: these are used to connect the transistors on their heatsinks to the "gubbins" in this and the 400V variant. For the 300V system built in this way, suitable holes must be drilled in the top and bottom of the box as shown to provide through-ventilation. It is found that mounting ZD10 above a hole in the bottom of the box and standing the box off the main chassis with spacers gives good temperature stability, even though the 300V unit will naturally run warmer if the transistors are mounted on the box itself. This technique cannot be employed for the 350V and 400V versions, since for these the constant current source is set up to provide more current and this, together with the increase in voltage, implies more dissipation in the transistors than can be safely handled if they are not mounted on a larger heat sink than is represented by the box.

Bearing in mind that the cases (*i.e.* the collectors) of the transistors are at high potentials above earth, it is strongly recommended that the thick mica washer which is normally supplied with the BU208 is used for mounting it on the box or the heatsink, and that transistor covers such as those shown in the photographs are used to obviate any shock hazard. In the event of the special mica washer not being available, it has been found that those supplied by *RS Components* under the stock number 401-396 are suitable for the job, being somewhat thicker than the commoner style of washer. When using these, bear in mind that heat transfer through the washer will not be as good as it would be with the ordinary thinner kind, so don't

	300V	350V	400V
TR1 current	30 mA	35 mA	40 mA
R5, R9	47K, 2W	62K, 2W	75K, 2W
R6, R8	68K	100K	150K
R7	180K	270K	330K
R10, R11	6K8	7K5	8K2
R18, R19	33K	39K	47K

**Table 1. Resistor values and standing current for different versions. Below, suggested uses for the different voltages (assuming EHT is 2 kV for '250, and 2.4 kV for '350).**

300V	4CX250B for mixed AB1 and C at VHF/UHF: gives good intermod. performance, needs slightly more drive than with 350V. Good valve life.
350V	4CX250R for mixed AB1 and C at VHF/UHF; 4CX250B for mixed AB1 and C at HF, AB1 only at VHF/UHF; 4CX350A and FJ at VHF (must <i>not</i> be used by Class C).
400V	4CX250R and 4CX350A and FJ at HF, especially where low drive only available. <i>Not</i> recommended for 4CX250B. Care needed with screen dissipation and loading.

Generally, valve life is better with lowest screen voltages, but drive requirements increase. Intermodulation performance is related to both screen and anode voltages, but with EHT as shown values suggested give optimum third-order performance for the different valve types.

---

Looking down inside the box. The presets at the top adjust the standing current in the constant-current sources for each channel. IC1 and IC2, with associated components, are visible in the centre, and the photograph gives some idea of the layout of the prototype 350V unit.

---

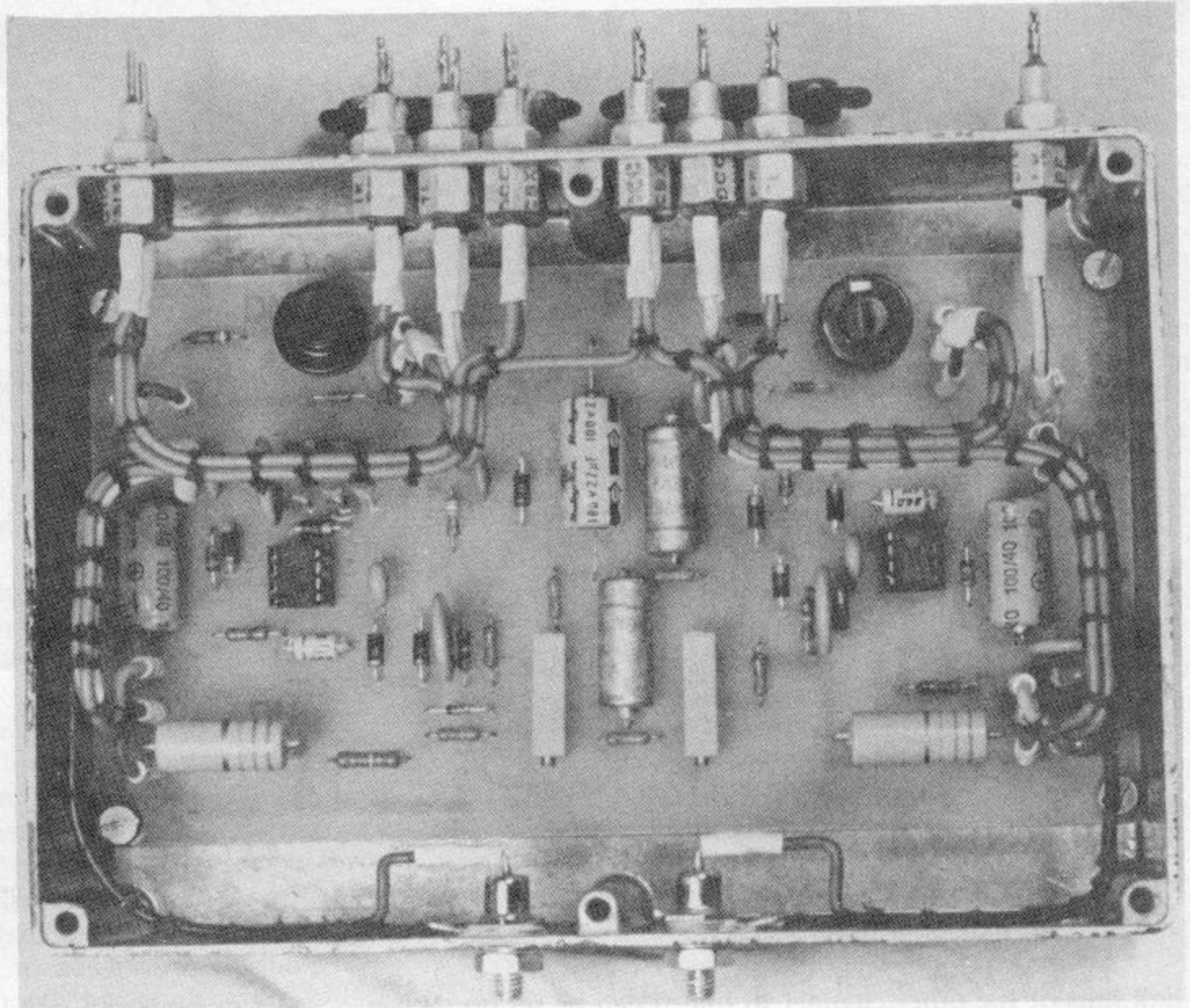

be tempted to skimp on the heat-sink compound! I know it's messy and smells foul, but the transistors will live longer.

Also on the subject of components, ZD7 and ZD8 are, as previously mentioned, 75V 20W devices. Originally BZY93C series components were used and, since the stud on all Zener diodes of this style is the cathode, they were insulated from chassis by the usual mica washer and brush. However, it was discovered from the *Mullard* data manual that BZY93 devices can be obtained in a package whereby the stud is the anode—which of course means that they can be mounted directly on the box, with a consequent improvement in thermal performance and, of course, reliability. These are given the suffix CR instead of C, and in fact all diodes in the BZY93 series have the Zener voltage given as part of the suffix; for example ZD7 in its original form was a BZY93C75 and in its other version it becomes — wait for it — a BZY93C75R. JEDEC alphabet soup! The only stockists of this series known to the author are professional companies such as *Farnell*, who do not supply to the private individual; however, prevailing upon your local friendly dealer should do the trick. It seems worth the effort, since the higher voltage devices in the BZY93 series do not seem to be all that common and may well have to be ordered—in which case one may as well opt for the BZY93CR style and save a mounting kit, gaining slightly better performance in the process.

ZD4 and ZD5 were two 15V devices in series in the early prototypes, since these gave slightly better performance than a single 500 mW 30V Zener. However, if a 5W 30V device is to hand it may be used instead, since its characteristics are much the same as the pair of 15V devices of lower power rating.

Finally, a note of IC1 and IC2. It has been found worth while to obtain good quality components for use here, since unmarked or unbranded 741's seem to vary somewhat in stability margins and also in noise performance. This is not an oblique way of saying that this design is in any sense critical or difficult to reproduce but rather that, bearing in mind that some care has been taken to obtain good performance, the

system will tend to give of its best with devices which are up to their specification. Any tendency to instability, such as was experienced with one channel of one of the prototypes on switch-on (to the tune of 8V pk-pk at about 85 kHz!) is highly likely to be due to deficiencies in the op-amp. and in the latter case substitution of an LM741CN on the offending channel completely cleared the problem. Further investigation revealed the facts noted above, so an extra 40p or so for branded components is a wise investment. Given this approach, the circuit is eminently reproducible.

A suggested PCB layout is shown, although it is not thought to be critical in view of some of the "bird's nests" used during development. However, decoupling where shown should not be omitted and if the transistors are mounted on external heatsinks, the wiring between them and the box should be kept short and well decoupled.

### Setting-Up

We may now consider the setting-up procedure. It will be noted from the circuit diagram that wire links are made between the outputs of the constant-current sources and the shunt stabilisers, and these should be removed to begin with: after setting-up is complete, they may be replaced with permanent link wires. In fact, it is much easier to set up the unit if two multimeters are available and it is strongly recommended that if, like the author, your shack only runs to one, another one is borrowed. If this is not possible, the link in the channel *not* carrying the reference chain should be replaced for the moment.

Assuming two meters are available, they should be inserted across the link pins and switched to measure current. On switch-on RV1 and RV2 should be adjusted for the required current (shown in the table). It will be found that, depending on the regulation of the input rail to the system, RV1 and RV2 will interact slightly, which is why an extra meter is useful here. If only one is in use, the "reference" channel *must* be set up first and then its link replaced and the meter inserted across the

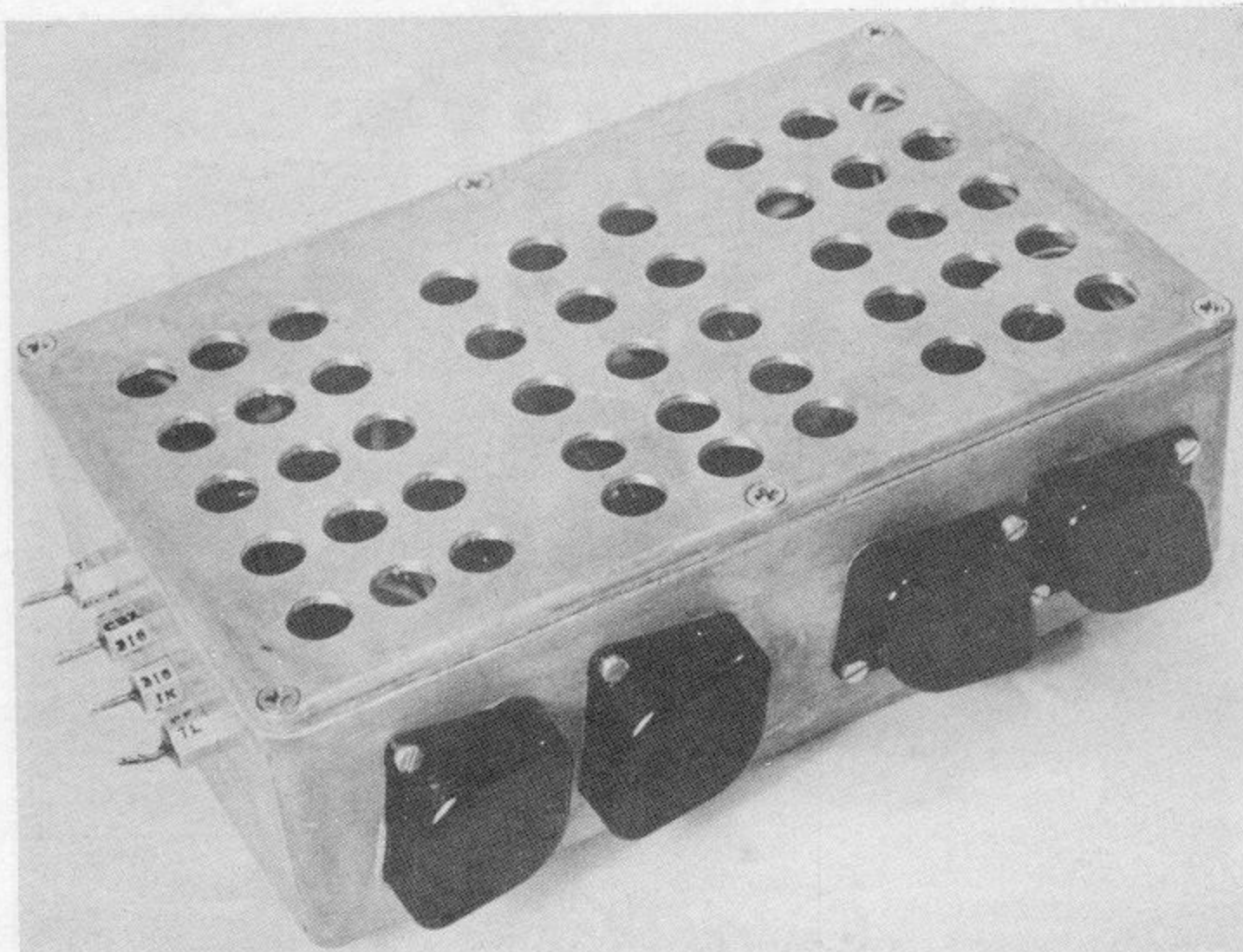

A 300V variant, Here the transistors are mounted on the box itself, and must be insulated with TO3 transistor covers as shown. Note the extra ventilation holes in the lid, in conjunction with a pair of similar holes in the base; the box is held off-chassis with tapped spacers, which permits cooling airflow.

link pins of the other channel so that it can be set up. When both channels have been set up for the correct current, the links can both be permanently wired-in.

If the meter is now moved to the output lines of the unit, it should be found that the output voltages should be within about 8V of the chosen value and are adjustable to the exact figure by means of RV3 and RV4. A DVM is useful here, since the adjustment is very fine and it is not easy to set up, say,  $350V \pm 1V$  with an Avo!

Next, measure the voltage across ZD3-4, *i.e.* the supply rails to IC1, and note its value. Then measure the voltage between the negative rail of the supply and the output (*i.e.* between pins 4 and 6 of IC1). Make a fine adjustment to RV1 so that this voltage is exactly half the voltage previously noted. This will give an optimum balance between source and sink performance of the unit. This is then repeated for the other channel.

The short-circuit current can now be tested by simply switching the meter to a safe current range and connecting it across each output supply to earth. It should be about 50 mA, and as discussed, its value can be altered by changing the value of R1.

After a few minutes' warm-up, the output voltage of each channel can be accurately set up and, if a suitable load resistor is available, the regulation can be checked. A load of 20 mA should not cause the output voltage to change. To check the system's ability to handle negative screen current, simulate this case by connecting a resistor between the input supply and one of the output rails and select its value so that about 20 mA flows into the output line. This should not cause the output voltage to change either, and is a rather more severe test of the unit than it will have to pass in practice. If both the above tests are satisfactorily completed, there will be no regulation difficulties when the unit is connected to an amplifier.

Finally, if an oscilloscope is available, the noise

performance and stability of the system can be checked under all load conditions. Noise should never be worse than 5 mV and any trace of instability, especially when the load is connected or removed, suggests that the 741 or, at the outside, C9 and C10, should be checked.

### Conclusion

This completes the high-performance 4CX screen supply system. As we have seen, in some respects the screen supply is the heart of the power supply for a linear amplifier using valves in this family and, particularly when the 4CX350FJ or A is used, it is the part of the system which amply repays attention to detail. The circuit shown here is more complex than either a Zener chain or a cluster of VR tubes but its performance in service is much better than either; and, as far as the author is concerned, it represents a design philosophy which is likely to become more and more necessary as band occupancy increases, the strong-signal performance of receiving systems improve and antenna systems get larger.

Next time we examine the final link in the chain in the shape of the EHT system, in the course of development of which the author has demolished more components than in any other project before or since!

*to be continued*

### PCB's, etc.

Melvyn Noakes, G4JZQ, is prepared to make available PCB's and complete modules for each stage of this power supply and control unit. He may be contacted at 21 Oxford Road, Finsbury Park, London N.4. (01-272 4135).

**"Short Wave Magazine" is the only periodical freely available from newsagents throughout the U.K. which is devoted exclusively to the pursuit and interests of Amateur Radio.**



# CLUBS ROUNDUP

By "Club Secretary"

## 35th "Magazine" Club Contest

WE are now reminding you that MCC time is coming up again — the friendly club contest which we have organised now for more years than we care to think about. There are a few changes, and we will mention them now, following up with detailed rules elsewhere in the piece.

First, then, a *Prize*. A small trophy, suitable engraved, for the overall winner; and another one for the best score outside the winner's country — thus if the winner is a G, this second prize will go to the best club score outside G.

Secondly, a *Challenge*. You challenge the local clubs (or a club from somewhere else for that matter); if they accept the challenge, and we are advised when the logs are sent in, then we will publish the results of this 'local derby' along with the main scores, in a separate tabulation, for all to see.

Thirdly, a *Bonus-Points* award, which will be, at the *Magazine* committee's discretion, to a club which has used the most initiative, within the rules of course, to advance their club's chance of winning. Filling the enemy with strong ale will not qualify for this bonus. . . .

So — there is something for your committee to think about and prepare for, aiming at a date of October 17/18; yes we know there is a clash, but looking at the W1WY Contest Calendar and the RSGB listings, not to mention the exhibitions, this date seems the least painful one!

## The Clubs

Perhaps the most notable thing this time is the number of updates and of new clubs — perhaps we should start with these new ones.

The Radio Club of **Thanet** is a new one based on Birchington Village Centre, where they are to be found on alternate Friday evenings from August 28. Details from the Hon. Sec. at the address in the Panel. Perhaps next time they would let us know what happened to the old Thanet group for our records.

**Skegness** it used to be said, is so bracing — now they have a radio club as well! They are booked in at the "White Swan", Burgh-le-Marsh, on the first and third Tuesday, and cater for a wide range of interests; we note they are setting up an RAE class, starting this month, for the May exam.

**Saffron Walden** have set up shop on the third Wednesday in each month at Debden Village Hall; not only do they hope to set up a decent programme, but the Hon. Sec. indicates an active interest in attracting newcomers into the hobby by showing them a little of what it's all about.

Not exactly a new society, but the first time this feature has heard from the **Royal Omani Amateur Radio Society**; their first newsletter is of great interest, showing as it does, a rapidly-increasing Omani membership and, in the matter of licensing (they have a committee to handle licensing questions), they are very aware of the need for a licensee to have been an SWL first — they require a log for six months SWL activity from Oman as part of the new licence; and for reciprocal licensing, membership of the club is a pre-requisite.

## The Rest

**Acton, Brentford & Chiswick** have a discussion about the 'necessity to increase activity on Ten Metres' on September 15 — a very good topic for a debate, and hopefully some action, too. The meeting is at Chiswick Town Hall, High Road, Chiswick.

Next we have a letter from **Axe Vale**, who report the death of their President, John Frisby, G8CA; he was a founder member and they reckon he had much to do with the club surviving the difficult periods; he was active on CW, chasing DX. Not only will the Axe Vale group miss him, but those who knew him in the earlier years. To return to the club, they are settled in to the George Hotel, Axminster, on the last Wednesday in the month. They say that, among other activities, they are trying to set up an RAE course, to start in October, for the May examination.

**Aylesbury Vale** haven't been around very long, but they seem to be making an impact; they are booked in every four weeks on Tuesdays at Elmhurst Youth Centre, Fairfax Crescent, Aylesbury. A talk on Raynet is down for September 8, while October 6 is down for a session on D/F by G6AGE.

Turning now back into the *environs* of London, we have **Barking** to mention next, based on Westbury Recreation Centre, Westbury School, Ripple Road, Barking. A talk on Moonbounce is scheduled for September 17, but they are open Monday to Thursday evenings every week.

Down in **Brighton**, they also have an RAE class set up at their Hq in 47 Cromwell Road, Hove; the first class will be on September 17. As for the meetings of the club, they occur on September 9 for a constructional contest, and 23rd to hear about Post Office and Radio Check time.

## Deadlines for "Clubs" for the next three months —

October issue — August 28th  
November issue — September 25th  
December issue — October 30th  
January issue — November 27th

*Please be sure to note these dates!*

**B.A.R.T.G.** provides a forum for all those who play their amateur radio by RTTY, whether mechanical, electronic, or whatever; a good newsletter, supplies of things of interest to RTTY operators, and various activities and conventions. Details from the Hon. Sec. — see Panel.

**B.A.T.C.** of course is the club for the amateur TV buffs; to include both slow-scan and fast scan TV. They write to advise us that they are holding their Exhibition and Open Day at the Post House Hotel in Leicester on October 4, the start being 11 a.m. Enquiries for stand space to G8GQS, QTHR.

We nearly overlooked locals **Braintree**, who have their AGM on September 28, at Braintree Community Centre which lies next door to the bus station in Victoria Street. More details from the Hon. Sec. — see Panel.

**Bromsgrove** foregather at Avoncroft Arts Centre, on the second Friday of each month; September 11 is down to a talk on spy sets.

**Chichester** next, with a talk on electronic game machines by Peter Brooks, on September 1; an extra event to commemorate G2NM, from 'Tidewaters' at Bosham on Sunday 13, and a junk sale on September 17. So — in general terms we are talking about the first Tuesday and the third Thursday each month, at the Lancastrian Wing of the Chichester High School for Boys, Basin Road, Chichester.

Our next stop is at **Cheltenham**; the Old Bakery, Chester Walk, Clarence Street, Cheltenham is the place, and the dates September 3 and 18. The former is, provisionally, down for G4EDA to talk about Cotswold Hospital Radio, and the latter is the natter night. As always, visitors welcome.

On we go to **Chiltern** who have a place at the John Hawkins' furniture factory, Victoria Street, High Wycombe, where they have the last Wednesday of each month. While we don't have details of the September meeting, we do know that on October 28 they have a talk on radio and TV interference by an officer from British Telecom.

## Names and Addresses of Club Secretaries reporting in this issue:

- ACTON, BRENTFORD & CHISWICK: W. G. Dyer, G3GEH, 188 Gunnersbury Avenue, Acton, London W3 8LB. (01-992 3778)
- AXE VALE: Mr. & Mrs. Retter, G4JBG, 48 Fairway Rise, Chard, Somerset TA20 INT. (Chard 4163)
- AYLESBURY VALE: M. J. Marsden, G8BQH, Hunters Moon, Buckingham Road, Hardwick, Aylesbury, Bucks.
- BARKING: A. Sammons, G8IZN, Lyndhurst Gardens, Barking, Essex IG11 5BZ. (01-594 2471)
- BRIGHTON: J. Trimmer, G4JDM, 7 Dale Crescent, Patcham, Brighton.
- B.A.R.T.G.: J. Binning, G3AJS, 293 Perry Street, Billericay, Essex.
- B.A.T.C.: M. Cox, G8HUA, 2 Holme Lane, Bottesford, Scunthorpe.
- BRAINTREE: A. Heritage, G4EOG, 25 York Gardens, Braintree. (Braintree 25109)
- BROMSGROVE: G. Taylor, G4HFP, 6 Marlborough Drive, Stourport-on-Severn, Worcs. DY13 0JH.
- CHELTENHAM: G. Cratchley, G4ILI, 47 Golden Miller Road, Prestbury, Cheltenham. (Cheltenham 43891)
- CHICHESTER: S. Talbot, G8FCX, 31 Pier Road, Littlehampton, W. Sussex BN17 5LW. (Littlehampton 5082)
- CHILTERN: P. B. Stears, G4LMM, 127 Hughenden Avenue, High Wycombe, Bucks. HP13 5SS. (High Wycombe 24095)
- CONWY VALLEY: J. N. Wright, GW4KGI, Eleven, Bryn Derwen, Abergele. (Abergele 823674)
- CORNISH: A. C. French, B.Sc., G8TUJ, 12 Pentalek Road, Camborne. (Camborne 717343)
- CRAY VALLEY: P. J. Clark, G4FUG, 42 Shooters Hill Road, London SE3. (01-858 3703)
- CRYSTAL PALACE: G. M. C. Stone, G3FZL, 11 Liphook Crescent, London SE23 3BN. (01-699 6940)
- DERBY: Mrs. J. Shardlow, G4EYM, 19 Portreath Drive, Darley Abbey, Derby DE3 2BJ. (0332-556875)
- DUDLEY: N. Rock, G3RLY, 28 Conway Avenue, Kingswinford, Staffs. (Kingswinford 277617)
- EDGWARE: H. Drury, G4HMD, 39 Wemborough Road, Stanmore, Middx. (01-952 6462)
- EX-G: F. W. Fletcher, G2FUX, 53 St. Ives Park, Ringwood, Hants. BH24 2JX. (Ringwood 3561)
- GUILDFORD: Miss H. M. Davies, 1 Dundee Cottages, Scotland Farm Road, Ash Vale, Aldershot, Hants. (Aldershot 310704)
- HARROW: C. D. Friel, G4AUF, 17 Clitheroe Avenue, Harrow, Middx. HA2 9UU. (01-868 5002)
- HEREFORD: S. Jesson, G4CNY, 181 Kings Acre Road, Hereford. (Hereford 3237)
- IPSWICH: J. Toothill, G4IFF, 76 Fircroft Road, Ipswich, Suffolk IP1 6PX. (Ipswich 44047)
- I.R.T.S.: C. Yeates, EI7AAB, 126 Beech Park, Lucan, Co. Dublin, Eire.
- LEEDS: C. D. Gledhill, 21 Warrels Place, Bramley, Leeds, W. Yorks. LS13 3NS. (Pudsey 567702)
- LOUTH: R. D. Wilson, G4IPE, 112 Uppgate, Louth, Lincs. LN11 9HG. (Louth 602220)
- MID-SUSSEX: J. Brooker, G3JMB, 20 Farnham Avenue, Hassocks, Sussex.
- NORTH BRISTOL: W. E. Bidmead, 4 Pine Grove, Northville, Bristol BS7 0SL. (Bristol 691685)
- NORTHERN HEIGHTS: R. Harker, G4CMK, 11 Buck Street, Denholme, Bradford. (Bradford 844442)
- PONTEFRACT: N. Whittingham, G4ISU, 7 Ridgedale Mount, Pontefract, W. Yorks. WF8 1SB.
- R.A.I.B.C.: Mrs. F. Woolley, G3LWY, 9 Rannoch Court, Adelaide Road, Surbiton, KT6 4TE.
- ROYAL OMANI: N. Edwards, A4XIQ, EIT, P.O. Box 81, Muscat.
- SAFFRON WALDEN: P. Carter, 84 Little Walden Road, Saffron Walden, Essex. (Saffron Walden 21697)
- SEFTON: L. Gurney, G4LBJ, 1 Endborne Road, Orrell Park, Liverpool L9 8DP. (051-523 6077)
- SKEGNESS: J. Joslin, G3NPY, 150 Roman Bank, Skegness, Lincs. PE25 1SE.
- STEVENAGE: S. Clarke, G8LXY, 126 Putteridge Road, Stopsley, Luton, Beds. LU2 8HQ.
- SURREY: R. Howells, G4FFY, 7 Betchworth Close, Sutton, Surrey SM1 4NR. (01-642 9871)
- SUTTON & CHEAM: G. Brind, G4CMU, 26 Grange Meadow, Banstead, Surrey.
- THANET: I. B. Gane, G8HLG, 17 Penshurst Road, Ramsgate, Kent. (Thanet 54154)
- TORBAY: H. Davies, G4DZH, 18 Bowland Close, Paignton, Devon TQ4 7RT. (Paignton 523063)
- U.K. HORIZONTAL FM: A. Dorsett, G8YLH, The Coach House, Dogmersfield Park, Dogmersfield, Hants. (Aldershot 850678)
- VALE OF WHITE HORSE: A. Lovegreen, G4FLX, 16 Church Lane, Wallingford. (Wallingford 37482)
- VERULAM: G. Dale, G3PZF, 16 Palfrey Close, St. Albans, Herts. (St. Albans 57665)
- WEST KENT: B. P. Castle, G4DYF, 6 Pinewood Avenue, Sevenoaks, Kent TN14 5AF. (0732 56708)
- YEOVIL: D. L. McLean, G3NOF, 9 Cedar Grove, Yeovil, Somerset. (Yeovil 24956)
- YORK: K. R. Cass, G3WVO, 4 Heworth Village, York.

Off we go now into the Principality, and in particular to **Conwy Valley**, where the local group is to be found at the Green Lawns Hotel, Bay View Road, Colwyn Bay; a look ahead to October indicates a special event, namely a visit from G2AMV, the current RSGB President, on Sunday, October 4, at Hq, starting at 2.30. The October meeting is on October 8, for a surplus sale. The general form is for the group to assemble on the second Thursday in each month.

“Alternative Forms of Energy” will be covered at the **Cornish** meeting on September 3, the speaker being G3KJK; the venue of



This year's Thames Valley A.R.T.S. NFD was a family occasion, with wives and children joining the club operators for a picnic on site at Guildford.

course is the **SWEB** Clubroom, Pool, Camborne. This group can muster sixty at every meeting, and have been able to do it for years, so they obviously have the right formula; and they also have a computer section based on the same venue but meeting on the second Monday of the month.

September 3 and 17 are the dates for **Cray Valley**; the former dates is down for a natter night, and the latter is a combined affair with Gravesend club, for G3MXJ and G3FXB to talk about Contest Operation, and American Antenna Farms. The Hq address is as ever at Christchurch Hall, Eltham High Street.

Reading the **Crystal Palace** newsletter, it would seem their Field Day activities have caused them to Have Adventures — a high wind and high mast with a big beam atop seem to have been the offenders. However, they will be foregathering again at Emmanuel Church Hall, Barry Road, SE22, on September 19.

Our next port of call is the top floor of 119 Green Lane, Derby, the Hq of the **Derby** group; they can be found there on Wednesdays. Thus, September 2 is down for a junk sale, and 9th is a natter night; September 16 should be well-attended as Pat Hawker, G3VA, is coming to talk Technical Topics. September 23 is a night-on-the-air, and on 30th there is another well-known visitor — Jack Hum, G5UM, will be talking about “VHF — Then and Now”. Derby is another club with an RAE class starting in September.

**Dudley** come next, and the Hon. Sec. reckons he might have saved himself (we think he means the club!) 14 pence by doing things a trifle differently; true, but at the cost of a missed deadline! Anyway, he's already lashed out, as this month's issue of the newsletter appears to have used some ink to make the embossing clearer! The lads have their Hq at Dudley Central Library, on the second and fourth Tuesdays in the month; September 8 is a slide and talk affair, with G4DGM, the subject

his visit to Morokulien. September 22 is set aside for Dr. Graham, who will talk about radio and X-ray astronomy.

**Edgware's** newsletter is quite entertaining on the subject of their VHF NFD, and of their club two-metre beam. It also tells us that 145 Orange Hill Road, Edgware on the second and fourth Thursdays is the way of things. That gives us September 10 for an Informal, and September 24 for a project evening, at least provisionally.

Naturally enough, the **Ex-G Club** caters for the folk who have emigrated, or for one reason or another live outside the UK. Apart from the newsletter, they keep in touch by way of nets, from the world-wide one to the local affairs covering individual countries. Details from the Hon. Sec. — see Panel.

Our next stop is **Guildford**, at the Model Engineers' Hq in Stoke Park, second and fourth Fridays; it is reliably reported that G5OD will be talking about his TR-7, on September 11.

**Harrow** come next and here the routine is to have meetings each Friday; a "special" is September 18, for the Annual Construction Contest. This group have quite an interesting newsletter, and Uncle Oscar this month gave us one of the best chuckles of the year. A pity about Auntie Agnes, too; she obviously isn't ham-trained. One thing we *couldn't* find was a note of the venue, until we discovered it in one corner of the front cover design — Harrow Arts Centre, High Road, Harrow Weald.

At **Hereford** the dates are all booked in at the rather ominous-sounding County Control, Civil Defence Hq, Gaol Street, Hereford, the first and third Friday in each month being the relevant ones.

**Ipswich** have once again sent us a copy of their super magazine *QUA*. From it we notice that their move from Handford House to the "Rose and Crown" was timely, as the authorities have decided to dispose of Handford House. So, each second and last Wednesday evening there are people in East Anglia heading for the "Rose and Crown", 77 Norwich Road, Ipswich. Programme details from the Hon. Sec. — see Panel for his address.

Another good newsletter is the "Printed News" from **I.R.T.S.** which this time carries on the front cover an early photograph of Marconi and his "shack". There is, indeed, so much 'meat' in this issue that there is no reference to the clubs and their meetings. However, IRTS is a national society, and the Hon. Sec. can probably tell you about all the EI activities.

Our next port of call is **Leeds**; we have a change of Hon. Sec. to note, and from the letterhead we see they are based on Old Hall Golf Club, Woodhall Lane, Pudsey. For the remaining details we must refer you to the Hon. Sec. at the address in the Panel.

**Louth** seem to have settled into the routine of a club quickly enough since their formation a few months ago; for the moment they have a place at Pleasant Place, off Ramsgate. Louth, where on September 8, G4IPE will give a demonstration of amateur television.

Back down to the south again, to **Mid-Sussex** who inhabit Marle Place, Leylands Road, Burgess Hill, where they have a fine Hq. September 17 is down for a junk sale, with a plea for a prompt start to this one — sounds as if they have lots of stuff to move!

A change of Hon. Sec. is noted by **North Bristol**, and he says they are still meeting at S.H.E. 7, Braemar Crescent, Northville, Bristol 7. An interesting snippet is that their RAE class is now full up, and no more candidates can be accepted this time. Other activities each Friday continue as usual.

Now we have to look at the newsletter from **Northern Heights**. Again a change of Hon. Sec. is to be noted; and we have to refer you to him for the September doings at the Bradshaw Tavern, Halifax. Doubtless by now the new committee will have it all nailed down.

**Plymouth** nowadays live in Tamar Secondary School, Paradise Road, Millbridge, and get together on alternate Mondays from August 24 — they are actively on the hunt for new members to join in their various activities.

Carleton Community Centre is home to the **Pontefract** lads every Thursday evening. On September 3 they have an RSGB tape-and-slide lecture on "The Human Machine as a Radio

## 35TH TOP BAND "MAGAZINE" CLUB CONTEST — RULES

1. *When and Where:* October 17-18, 1700-2100 GMT, Top Band.
2. *Mode:* CW only Saturday evening, Phone only Sunday evening. A valid entry will show contacts on both evenings. (But see also Rule 8).
3. *Scoring:* Score three points for a club contact, one for a QSO with a non-club station. Multiplier of one for each county, administrative area, or country. Total score is QSO points times multiplier, times 1.5 for the CW leg of the contest.
4. *Geographical:* Entries from Devon, Cornwall, Scotland, Ireland, GD, GJ, GU, or outside the British Isles to multiply the score obtained in Rule 3 by 1.5.
5. *Callsign:* If possible, the club call should be used. If a member's call is used, it should be clearly noted, and it is preferable to use the same call throughout; if a different call is used on each night, this shall be clearly noted on the entry.
6. *Contest Exchange:* Call "CQ MCC". Exchange RS(T) plus a serial number of three digits, starting at any number and rising sequentially by one for each completed QSO. Club station to so indicate (CLB acceptable on CW), and all stations shall give in suitable form their county/admin. area. For overseas stations, country will be acceptable.
7. *Disqualification:* Will result from bad operating practices, poor signal quality or excess duplicate contacts. No correspondence can be entered into on this matter.
8. *Entries:* These are to be postmarked *no later* than 21 days after the end of the contest. Logs to include the usual declaration. An entry may be made from any part of the world having Top Band facilities, and UK stations should operate with this in mind. Should a club be unable to operate on both evenings for any reason, they may enter a check log, and should there be many such, they may be separately tabulated. Individuals are also invited to submit a check log.
9. *Prizes:* A small trophy will be awarded to the winner, suitably engraved, for the club's permanent keeping. In addition, a similar trophy will be awarded to the top scoring club outside the country in which the winner resides.
10. *All entries* to be addressed to the Contest Committee, MCC, SHORT WAVE MAGAZINE, Welwyn, Herts. AL6 9EQ. It is hoped to show results in the January 1982 issue.

*Additional data:* It has been the tradition of MCC for many years to include comments from entrants and check logs, and photographs of stations in action. So, your comments please, grave or gay, on MCC as you saw it, and if possible a photograph. This would be as much appreciated from clubs at the bottom, as well as the top, of the score-listings.

Don't forget to challenge another club to a private battle, letting us know which and how you got on. See also p. 377, this issue.

Operator"; while on 17th, G3KWT will talk about Raynet, and, if time permits, will recount his tales of battles with the planners.

The latest issue of **R.A.I.B.C.'s** "Radial" begins with a message to those involved with amateur radio and this Year of the Disabled, from King Juan-Carlos of Spain, who as most readers will know is himself a radio amateur. If you know of any blind or invalid folk who are interested in SWL or the possibility of getting a licence, you will do them a fine service by putting them in touch — and of course there are always Representative and Supporter vacancies! Details from the Hon. Sec. — see Panel.

# STEPHENS-JAMES LTD.

47 WARRINGTON ROAD, LEIGH, LANCS. WN7 3EA  
Telephone (0942) 676790

SEE US ON STAND 13, AT THE A.R.R.A. 10th AMATEUR RADIO EXHIBITION, CASTLE DONNINGTON, 29-30-31 OCT.



£258.75

### BEARCAT 220 FB

Specifications.  
Frequency range:  
Low Band Mobile..... 66 - 88MHz  
Aircraft..... 118 - 136MHz  
Amateur Band..... 144 - 148MHz  
Public Service & Marine..... 148 - 174MHz  
UHF Amateur..... 420 - 450MHz  
UHF Band..... 450 - 470MHz  
UHF Band..... 470 - 512MHz



### TR9000

The TR9000 is a compact lightweight 2 mtr. FM USB/LSB/CW Transceiver with an outstanding array of functions. FM1 for 25 KHz steps (for mobile use) FM2 for precise 100 Hz steps (for base station use). Microcomputer control giving many advanced features. Built in 5-channel memory. New type microphone with UP/DOWN switching. Built in high performance. N. Blanker. Side tone for CW.



### J.R.C. NRD515D

General coverage receiver 100 KHz to 30 MHz fully synthesised. Digital readout PLL synthesiser with rotary type encoder pass band tuning - modular construction. £949.00

ACCESS & BARCLAYCARD facilities. Instant HP service. Licensed Credit Broker - quotations upon request.

Try our new "Overnite" service for £6.00. Guaranteed 24 hour service if order placed before 11 a.m. (except North GM).

Part exchange always welcome. Spot cash paid for good clean equipment. If you have equipment surplus to your requirement we would be pleased to sell this on commission for you.

Shop Hours: 9.30 to 5.30 Monday to Friday.  
4.30 p.m. Saturday.

No parking problems. Turn at the Greyhound Motel on the A580 (East Lancs.) Road. S.A.E. with all enquiries. 25p will bring you latest information and prices. Postage carriage extra.

ALL OUR PRICES INCLUDE VAT  
SEND S.A.E. FOR OUR UP-TO-DATE SECONDHAND LIST.

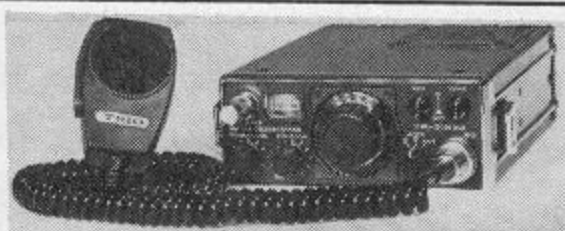

### TR2300

TR2300 2m Synthesised Portable Transceiver. We have lost count of the number of this model we have sold over the last 12 months. Hikers, campers, climbers, you can hear them all over the country and reliability which is the essence of TRIO equipment. £166.75

### JAYBEAM

5Y/2m 5 element yagi.....	£11.27
8Y/2m element yagi.....	£14.49
10Y/2m 10 element.....	£31.05
PBM/14/2m. 14 element Parabeam.....	£44.80
5XY/2m. 5 element crossed yagi.....	£22.77
8XY/2m. 8 element crossed yagi.....	£28.40
10XY/2m. 10 element crossed yagi.....	£37.72
Q4/2m. 4 element Quad.....	£23.69
Q6/2m. 4 element Quad.....	£31.39
D5/2m. 5 over 5 slot fed yagi.....	£20.12
D8/2m. 8 over 8 slot fed yagi.....	£27.40
UGP/2m. ground plane.....	£10.12
MBM48/70cms. Multibeam.....	£28.75
MBM88/70cms. Multibeam.....	£39.33
TAS 1/2" 2m. Whip mobile.....	£15.29
C5/m. Colinear.....	£44.27
C8/70cm. Colinear.....	£50.00
D15/1296 23cm. Antenna.....	£34.04
Carriage on Antennas £4.50.	

### TRIO

TS830S HF Transceiver.....	£726.57
AT230 ATU-SWR Power Meter.....	£121.21
TS530S HF Transceiver.....	£561.20
SP230 Speaker.....	£37.72
TS130S HF Transceiver.....	£547.40
TS130V HF Transceiver.....	£450.80
PS20 Power supply.....	£48.30
AT130 100 watt antenna tuner.....	£81.19
R820 Amateur Band Receiver.....	£690.00
TL999 2KW Linear amplifier.....	£595.70
TR9000 2m Multimode Transceiver.....	£371.91
BO9 Base plynth.....	£36.11
TR7800 2m FM Transceiver 10watt.....	£276.00
TR7850 2m FM Transceiver 40watt.....	£324.07
TR2300 2m FM Portable.....	£166.75
VB2300 10 watt Amplifier.....	£55.43
TR2400 2m FM Hand held portable.....	£198.95
ST1 Base charger.....	£43.70
TR8400 70cm FM mobile Transceiver.....	£329.13
TR9500 70cm multimode Transceiver.....	£482.54
R1000 General coverage receiver.....	£305.95

Full range of accessories available.

### DRAKE

TR7 Digital Transceiver.....	£1,035.00
PS7 Power Supply.....	£207.00
RV7 Remote VFO.....	£138.00
MS7 Speaker.....	£29.90
R7 Digital Receiver.....	£989.00
Filters for TR7.....	£39.10
FA7 Fan for TR7.....	£20.70
MN7 ATU/RF Meter 250 Watts.....	£124.20
MN2700 ATU 2 KW.....	£207.00
DL 300 Dummy Load 300 Watts.....	£20.70
DL 1000 Dummy Load 1 KW.....	£37.95
TV 3300 Low Pass Filter.....	£18.40
AK75, Doublet Antenna 132' top with 470 ohm Feeder.....	£23.00



### R820 RECEIVER

THE ULTIMATE IN RECEIVERS

Frequency coverage 160-10m plus SW Broadcast Bands. All modes CW-USB-LSB-RTTY. Digital Readout. Noise Blanker. Fully variable. I.F. Bandwidth, plus Bandpass tuning, plus rejection notch filter. £690.00

### TRIO TS530S NEW £561.00 ALL BAND HF TRANSCEIVER

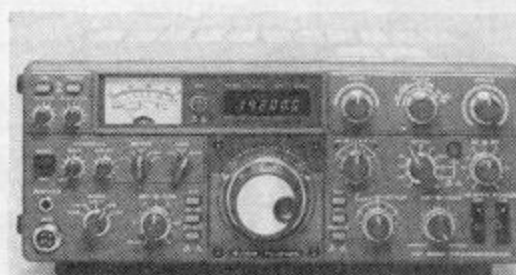

### TS830S

### HF SSB TRANSCEIVER £726.00

The new TS830S, the latest from TRIO. A high performance, very affordable HF SSB/CW transceiver with every conceivable operating feature built in for 160 through 10metres (including the new three bands). The TS830S combines a high dynamic range with variable bandwidth tuning (VBT), IF shift and an IF notch filter, as well as very sharp filters in the 455 KHz second IF. Together with the optional VFO230 (remote digital display VFO) which provides split frequency operation and 5 memories for frequency hold, the amateur has available today's advanced technology linked to the proven reliability and exceptional linearity of a valve PA.

- ★ VBT variable bandwidth tuning
- ★ IF notch filter
- ★ IF Shift
- ★ Various filter options
- ★ Built in digital display
- ★ 6146B final with RF negative feed-back
- ★ Optional Digital VFO for increased flexibility
- ★ Innovative PLL system of frequency generation
- ★ RF speech processor
- ★ Adjustable noise blanker level
- ★ Adjustable audio tone
- ★ RF attenuator
- ★ RIT/XIT
- ★ SSB monitor circuit
- ★ Expanded frequency coverage



### TR7800

Continuing TRIO's policy of presenting the Radio Amateur with the finest equipment available, we were pleased to announce the NEW TR7800 2m FM Mobile Transceiver. 15 memory channels - Priority channels with simplex ±600 KHz or non-standard operation - "Priority alert" bleeps when signal on M14 priority channel. Frequency coverage 144.00, 145.955 in switchable 5 KHz or 25 KHz steps. Front keyboard for selecting frequencies, programming memories and controlling scan function. ALL THIS and MORE for £276.00.

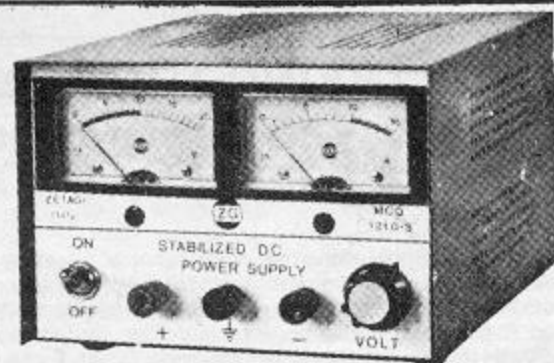

### MOD. 1210 S

SOLID STATE STABILISED POWER SUPPLIES

Maximum ratings quoted. Prices include postage.	
Model 125 10-15V 5amp.....	£29.50
Model 156S 4-15V 5amp Twin Meter.....	£40.00
Model 1210S 4-20V 10amp Twin Meter.....	£75.00

NOW AVAILABLE FROM STOCK THE WHOLE RANGE OF "DATONG" PRODUCTS AT CURRENT PRICES.

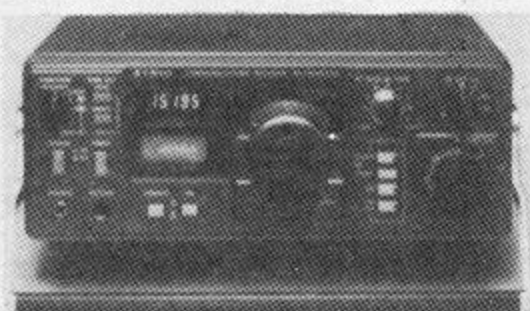

### TRIO R1000

R1000 receiver £305.90  
The latest general coverage from Trio. Frequency coverage 200 KHz to 30 MHz in 30 bands. Using an advanced PLL system. Full digital readout. Three filters 12 KHz for AM - 6 KHz narrow AM and 2.7 KHz SSB. Also incorporates a noise blanker. Operation is from 100-240 V AC or 12 V DC.

### RECEIVERS AND TRANSCEIVERS

(Inc. VAT and Postage)	
SR9 Tunable 144-146MHz Receiver.....	£46.00
R512 Aircraft Band Scanning Receiver.....	£135.00
Regency Digital Flight Scan Synthesised Aircraft Band Receiver.....	£215.00
Yaesu FRG7 Receiver.....	£199.00
'Sky ACE' Hand Held Aircraft Band Receiver.....	£49.50
AR22 2m Hand Hold Receiver.....	£83.00
SX200N Scanning Receiver.....	£264.75
FDK 700EX Transceiver.....	£199.00
FDK 750E Transceiver.....	£299.00
Standard G7R UHF Transceiver.....	£209.00
Bearcat 220FB Scanner Receiver.....	£258.75

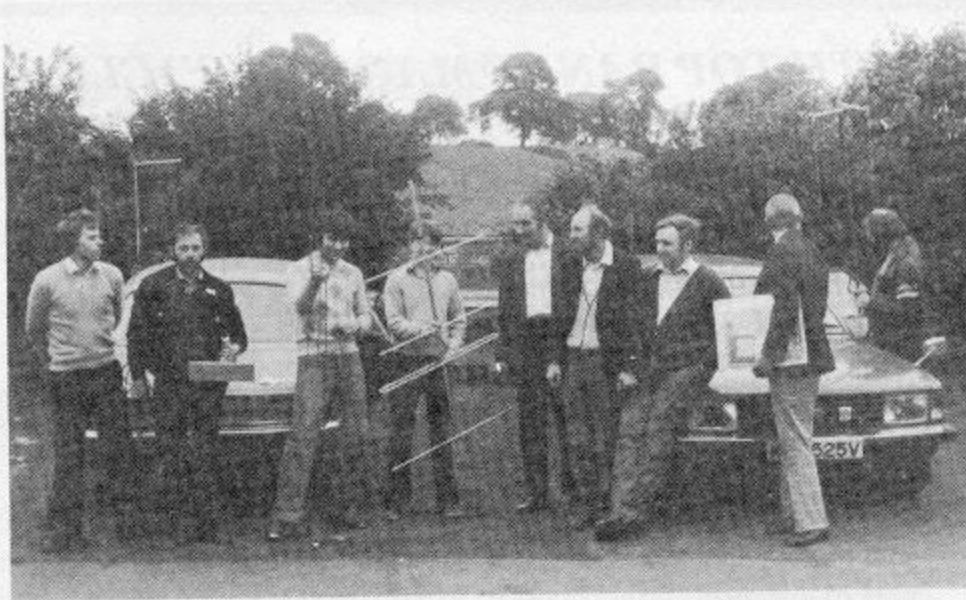

Above, members and visitors with equipment before the start of Pontefract and District A.R.S.'s 2m. D/F Contest on June 25th; left to right, Neil G8VFF, Harold G6BCN, Ken G8YFX, Jonathan G8YQZ, Brian G8ZMN, Les G8YFN, G8GXN, SWL Ted, and a visitor. The Foxhunt was a great success and, as usual, the thirsty work involved in catching the Fox led to a local. Below we see, after the contest, at the "Spread Eagle", Darrington, from left to right, Bob and Rae Firth (G3WWF and G4JMT), Stephen (jnr. op. of G4DIO), Alan G3DIO; in front is Jim G4JNO (whose wheelchair was no obstacle to joining in), SWL member Bill Hartley (who donated the trophy), Ken G4FPO (the Fox), Tony Lightowler G6BGN (the winner), Catherine G4KWL, Reg G4KMW, Neil G8VFF and John G4LOS (both at rear), Les G8YFN, a member Otley A.R.S., and Jonathan G8YQZ. It is planned to make the Foxhunt an annual event.



A special-event station at the National Giro Centre, signing GB2NG is to be run by **Sefton**; for more details of this, and the club itself, contact the Hon. Sec. — see Panel.

The **Stevenage** club newsletter carries a long article on the UOSAT device which will, if all goes well, become OSCAR 9 shortly after this reaches you. To return to club matters, they have space in the canteen at the British Aerospace Plant B, where on September 3, they have a talk on video recorders by G6ADX. We don't have any data on the September 17 session, but it will by now have been finalised.

Over at **Surrey**, they have G4FRX in person talking about the use and abuse of the 4CX250 series valves (at the very time this is being written); but 34 The Waldrons, South Croydon will in September see, on 7th a surplus equipment sale, and on 21st a surplus book sale. This last is something we've not seen in a club programme before, but it does seem to have possibilities.

**Sutton & Cheam** now, and we have it that September 11 will be meeting at Banstead Institute, while on 25th, the venue will be Sutton College of Liberal Arts, these being the first dates of the new "season" for the gang; subjects for those were being finalised by the committee at the time their newsletter was written.

It seems a little odd to see **Torbay** letterhead with the signature of G2CWR on it. Their Hq is at Bath Lane, rear of 94 Belgrave Road, where they have informal evenings each Friday and a formal business-and-lecture session on the last Saturday of the month. Their NFD yielded a respectable score, and beautiful weather, with *no* snags. Quite clearly Murphy is brewing something extra-special up!

The **UK Horizontal FM Group** is a self-explanatory name; and we hear they are receiving applications for membership from Norway, Holland, Ireland and Germany, as well as UK. Details from the Hon. Sec. — see Panel. A pity their contest is on the same day as the second part of MCC, although they do not actually clash.

Even in the beautiful **Vale of the White Horse** there are radio amateurs (are they *everywhere?*), and on September 1 they are off for a visit to British Telecom Leafeld transmitting station. The other Tuesdays in September will be informals at the "White Hart", Harwell, starting around 8.30. Doubtless the Leafeld trip will be fully booked by now.

Next we head for **Verulam** who have their main meetings at the Charles Morris Memorial Hall, Tyttenhanger Green, Tyttenhanger, Near St. Albans; September 22 is down for G3WZT talk about "Meteor-scatter and other Phenomena". In addition they have informals on the second Tuesday in each month in the R.A.F.A Hq in Victoria Street, St. Albans.

At **West Kent** the venue is the Adult Education Centre, Monson Road, Tunbridge Wells, except for September 4 which is down for two-metre Foxhunt (meeting behind Marks & Spencer at 2000 o'clock). On September 18 they have an Open Evening with a special welcome to newcomers to the hobby; displays of equipment, a working HF station, and a book sale, not to mention members standing by to answer questions. Sounds like a good idea all round. Looking ahead, on October 2, Jocelyn Burnell will be talking about "Pulsars, the Radio Astronomer's Puzzle". This lady, as a student, discovered the phenomenon, and is still active in the astronomical field, examining stellar-X-ray sources and attending international gatherings as well as looking after house and family.

When we get to **Yeovil** we know the end of the pile is near; this group use Building 101, Houndstone Camp, as their Hq, and are there weekly. The programme looks like: September 3, a hints and kinks night; September 10 G3KSK on "My Favourite QSL Cards"; on 17th G3MYM asks "What is Power Output?", and on 24th there is a natter night.

At **York** the gang make a thing out of showing the public what our hobby is about, by way of lots of special event stations; and it has paid off, as at least one YL visitor went off from GB2GYS fully intent on getting a ticket so she can operate with the group next year. To find the group, try the United Services Club, 61 Micklegate, York, on Fridays, *except* the third one each month.

## Finale

That's it for another month; in order to get room for the MCC details we had to prune very hard, but we hope we haven't left any recent reporters out. The deadlines for arrival of your news are, as usual, in the 'box' in the body of the piece. The address, as ever, is "Club Secretary", SHORT WAVE MAGAZINE, 34 High Street, Welwyn, Herts. AL6 9EQ.

## Welsh Convention

This year's Welsh Amateur Radio Convention will be held at the usual venue, Oakdale Community College, Blackwood, Gwent, on Sunday, 27th September. There will be films for the HF DX enthusiast, a lecture by GJ4ICD for the VHF enthusiast, and films for newcomers to the hobby; also a major TV demonstration. In addition there will be trade stands, and talk-in on S22 starting at 9 a.m. The Convention will be opened at 11 a.m. by G2AMV, President of the RSGB. Refreshments will be served, and the admission fee of £1 also means eligibility for the draw to win a major raffle prize. Further details may be obtained from B. Davies, GW3KYA, QTHR (tel: 0495-225825).

# “A Word in Edgeways”

Address your letters for this column to “A Word in Edgeways”, SHORT WAVE MAGAZINE, 34 High Street, Welwyn, Herts. AL6 9EQ.

Dear Sir — I have read with interest the recent, and current, series of articles by G4FRX on the use of the 4CX's in VHF amplifiers, and feel moved to speak up against the “use only best quality, bought new” brigade. Where is the true amateur spirit, or to put it another way — what's wrong with a gamble?

A pair of brand new 4CX250's plus bases will cost around £50. The really dubious quality ‘no numbers’ types to be found in a bag at a rally will be 50p to £1 each: not bad odds. As for bases, two unknown-vintage military ‘heaps’, bearing more relationship to a waste-paper bin than electronic equipment, provided me with mine at a cost of £1 for the two. The resultant amplifier was built with an excess of enthusiasm and a lack of knowledge, but I learnt along the way. That's what it's all about, isn't it?

Sure, the EHT transformer caught fire and had to be replaced by a bigger one; and yes, I had some complaints about spreading, but an attenuator to reduce drive cured that. The amplifier, as it stands, has worked well for the past four years, and incorporates the following star features: (a) a pair of ‘muffin’ type fans, one for blowing in, the other for sucking out (the latter having been replaced once); (b) the fans only run whilst on transmit; (c) the screen supply is a transformer, a bridge and a capacitor, and has never been visited by a current meter; (d) the fans, and the primaries of the EHT and screen supplies, are switched (via a relay) from the PTT line simultaneously.

Whilst I have every respect for these articles, which must detail the correct approach, I offer the above as an indication of what I got away with, secure in the position of 400 hours' use behind me (about two one-hour sessions a week) with only the fan failure. Having said that, naturally it will go wrong tomorrow!

H. Allison, G3XSE

Dear Sir — In reply to the letter by G4DHF in the August issue, there is an obvious way to fight back. I don't know if it is taboo to suggest such a thing, but isn't it time the RSGB approached the Home Office with a request that G8's should be allowed to operate on 28 MHz? If CB-ers can operate on 27 MHz, there can be no reasonable argument against it.

I'm sure the G8's would do a good job in the fight to protect that which is ours.

Hector Cole, G3OHK

Dear Sir — I feel loath to further the “Great CB Debate”, but a couple of recent experiences have caused me some concern. I should say first that I have a live-and-let-live attitude to CB, which is perhaps as well being the vicar of a parish with an estimated 100 or more active CB operators.

Some short time ago I visited a local CB shop in Birmingham and was dismayed by the catalogue of horrors I found there:

- (1) The shopkeeper was using an AM CB transceiver to advertise his wares to drivers on the M6, and offering talk-in to buy his ‘goodies’.
- (2) AM, FM and SSB CB transceivers for sale with all extras.
- (3) A whole shelf of linears, most of which were capable of output powers above the legal limit for licensed amateurs.
- (4) A couple of amateur-band transceivers for sale, for the 10-metre band “the amateurs don't use”.

All of these are now illegal, and I suspect most of them will remain so in the future. But my attempts at friendly conversation with a few CB-ers there revealed other horrors. They spoke of the new CB proposals with distaste, and assured me that most currently active CB-ers will not use FM “because AM gets further”, and that they will probably not bother to get a licence —

“why should we pay, we don't now”.

I suspect, in common with the Editor of this magazine, that Timothy Raison has bitten off more than he can chew, and has acted unwisely and in haste; but I feel it would be out of place to voice our suspicions about commercial interests and politics.

I wish legitimate CB-ers well: may they enjoy themselves. Radio has been a great source of pleasure for me. But I hope Mr. Raison manages to produce proposals to prevent the illegalities foreshadowed above. I can only echo some of David Johnson's, G4DHF, views (August S.W.M.) and suggest that tighter limitations be imposed on the sale of equipment, which ought to include:

- (1) The sale of illegal equipment to be an offence.
- (2) The sale of legitimate CB equipment to licence-holders only.
- (3) The sale of amateur bands equipment only to licensed amateurs.

Rev. G. C. Dobbs, G3RJV

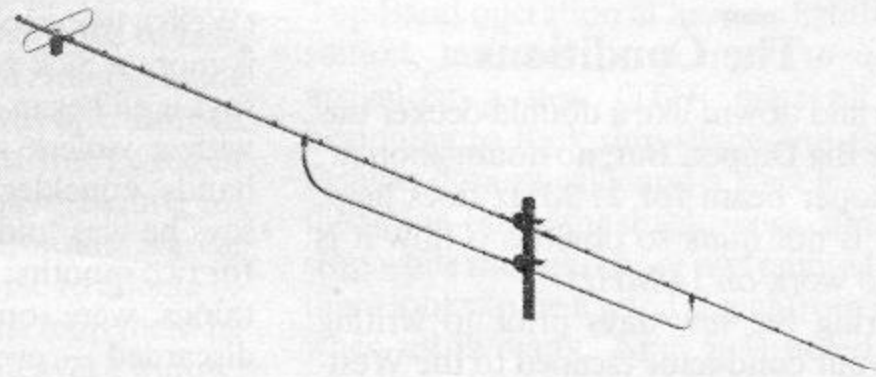

Above, a 23-element DL6WU long-yagi for 432 MHz with 17.9dBi gain. Below, a 70cm. antenna system using four 23-element DL6WU yagis stacked vertically giving approximately 23dBi gain, vertical polarisation being provided by a pair of 16-element DL6WU's giving about 19dBi. These antennas, which are made in Germany by H.A.G., are obtainable through the sole UK agent, *muTek Limited*, Bradworthy, Holsworthy, Devon EX22 7TU (tel: 040924-543/8), who should be contacted for full details, specifications and prices.

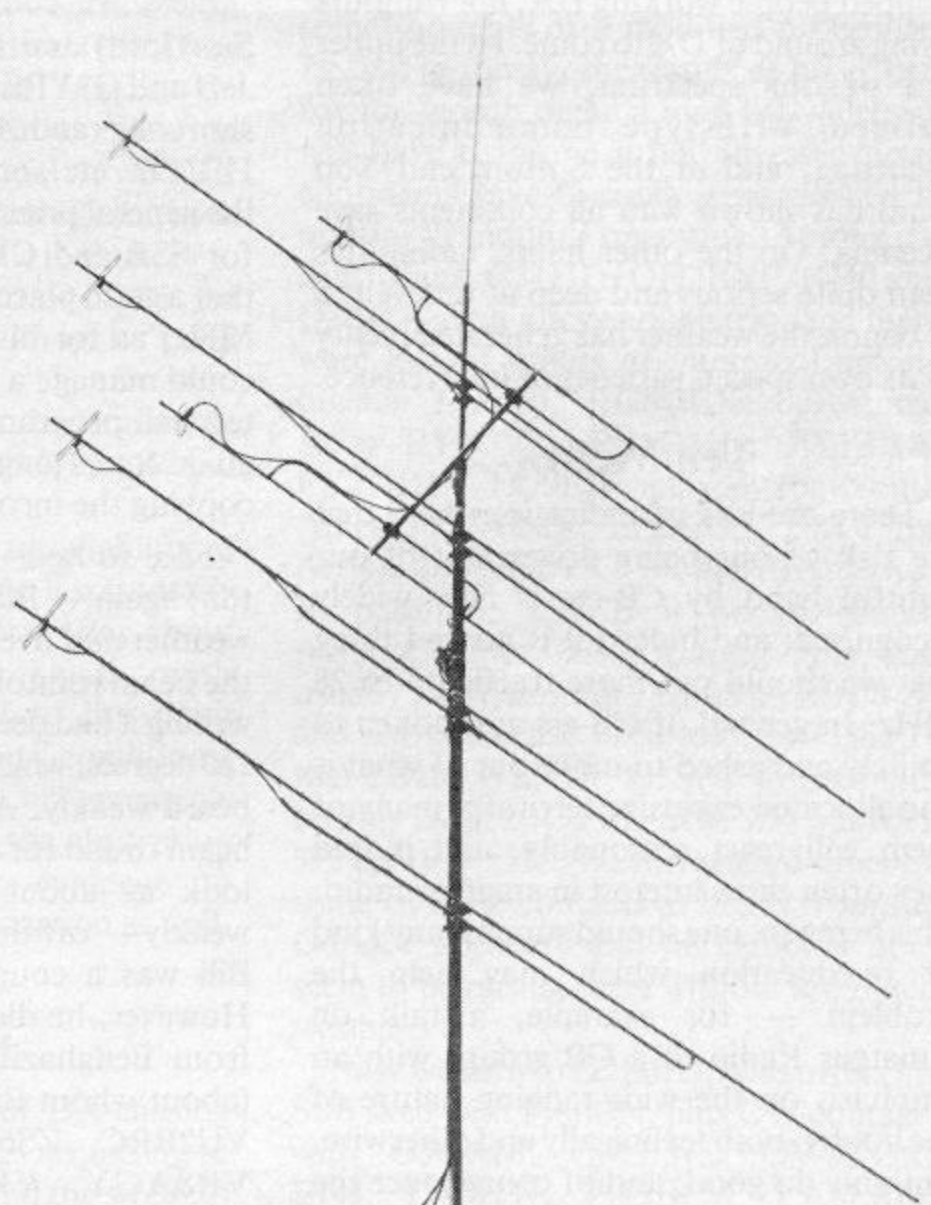

# COMMUNICATION and DX NEWS

*E. P. Essery, G3KFE*

**E**LSEWHERE we have given the Rules for MCC; much as last year, save for the addition of a small prize. So — why mention it here? Simply that we get the feeling the 1.8 MHz band is once again being used by “average amateurs” even if most of the local nets have migrated to other areas. And, of course, the possibilities for a bit of DX on the band is far greater than it ever has been. So why not get your own club or group into the act? Challenge the club up the road (pints per point either way?) and have fun doing them in the eye, as well as placing in the nationals. If you are a loner, come on and give a point to a club or two, and then let the Contest Committee have a check log.

## The Conditions

Up and down, like a double-decker bus on the Big Dipper. But, no doubt about it, our sloper beam for 21 MHz does help. What is not *quite* so obvious is how it is able to work on 14 MHz!

During the few days prior to writing this, your conductor escaped to the West-country and so, it seems, was lucky enough to miss a quite fantastic performance from the weather-gremlins — perhaps making up for their good offices in two Test Matches.

However, to look at the bands in more detail; the summer conditions have continued, but, as we shall see, that hasn't stopped people working DX, nor rumours flying around of DX to come. At the upper end of our spectrum, we have often noticed VHF-type communication occurring, and at the bottom end Top Band has shown with all continents save Oceania. On the other hand, fading has been quite serious and deep at times, and of course the weather has generated plenty of its own special varieties of interference.

## Ten Metres

There are lots of indications here that the risk of our being driven out of our rightful band by CB-ers is now widely recognised; and indeed it is no bad thing that we should put more traffic on to 28 MHz. In general, if CB-ers are spoken to politely and asked to move out of what is our allocated exclusive territory, many of them will react reasonably, and indeed they often show interest in amateur radio. This being so, one should support any kind of re-education which may help the problem — for example, a talk on Amateur Radio to a CB group, with an emphasis on the wide-ranging nature of the hobby, both technically and otherwise, can only do good; and of course once the

position and legality of CB have been cleared up, their REACT could form a useful adjunct to RAEN.

However, if the increasing spill-over into the CW end of Ten is to be stopped, we will have to accept that to call them and ask them to move on Phone is necessary, even though this is the CW part of the band. If they won't move, then they will have to be moved — practice your CW contest calls on top of a stray CB signal, and keep on until they get the message — if it happens to be a cross-town CW QSO, using break-in and on slightly different frequencies, so much the better.

But we have been diverted from our prime subject . . . Starting with G3PKS (Wells), who reckons his offering this time is more a Sick Note than a DX list! Jack says it all began at the back-end of March with a violent attack of the ‘screws’ in hands, knuckles, shoulder and back — he says he was ‘old misery-guts’ personified for two months; but at the time of writing, things were on the mend, and sticks discarded — even a drive in the car. The score in QSOs during the period wasn't a lot — some half-dozen on Ten only. However, the odd half-hour ragchew on CW had a marked therapeutic effect and lifted morale no end. Quite surprising the difference in muscle usage between the el-bug and a straight key — Jack has one of the former.

Now we come to G3LWM (Bishops Stortford) and the ten-metre UK group. Jeff and G3YPZ both noted the amount of short-skip and *Ar* on Ten, from GM, SM, HB, OZ, etc., on FM. Later in the evening the general practice is to go down the band for SSB and CW contacts. Jeff reckons that a good place to try a call is around 28.6 MHz; as for his CW, Jeff says he never could manage a bug key, so he now has a test call programme organised which will go on for as long as required — no trouble copying the incoming stuff.

Nice to hear from G2ADZ (Chessington) again — Bill had been a bit under the weather *and* overworked, and to crown it, the beam rotator jacked-in. At the time of writing it had decided to work only through 180 degrees, which resulted in VK9YC being heard weakly. A bit of a struggle got the beam round for next morning, but a quick look at about 2300 revealed CE0AE weakly — off the back of the beam! So — Bill was a couple of QSOs light there. However, he did find 9U5WR, ‘5A7BQ’ from Benghazi saying QSL *via* W3BCI (about whom Bill has doubts), FC0FRV, VU2BRC, ZS6BW, EL2AV, 9X5AB, VP8AGY, VK7GK, ZS6AXI/3D6,

CP3CN, 6W8IH, J5AG, and FP8HL. Gotaways included A9XCE, VS6JR, 4S7FG, and TL8CN. Turning to the beacons, Bill mentions hearing ZS1STB (28.302 MHz), W8OMV (28.287), TU2ABJ (28.271), ZS3HL (28.233) and HG2BHA (28.233). As G2ADZ says, so few in USA and Canada, and so many in Africa.

We have two letters from G3LDS (Chelmsford), the first one being a late arrival for last month, and the second to indicate the ‘death’ of a rig; the corpse was ‘sent to the doctor’ for a repair/re-alignment job, so of course more gardening was done. However, prior to this, G4LDS worked quite a lot, often by a CQ call on a ‘dead’ band; YC1GJ, G3YPZ/A with details of the activity group already mentioned, FH8OM for a new one, ZE1AN, and a couple of hours later ZE1AV. Then 5R8BRJ, with a FT-101 plus linear and saying no QSL either direct or *via* RSGB — so the question arises of a Phoney. On the other hand, this contact was followed by a call from ZS1FF at a lower signal strength; and the writer has heard 5R8AL recently.

## “CDXN” deadlines for the next three months —

October issue — September 3rd  
November issue — October 1st  
December issue — November 5th

*Please be sure to note these dates.*

Now to G4HZW (Knutsford) who reports that during the period in review he dropped the quad for a rebuild, and pensioned-off his FT-75 in favour of a TS-820; the quad seems much better, with an improved F/B ratio, and of course the extra bit of power helps. Tony was a bit surprised at the lack of 28 MHz reports earlier, as he managed with the old set-up to work 4U1ITU, 3B8DB, SV0AP, KP2A on Desecheo, a couple of VKs, long path, at midnight, LU5HEN, some UK9 and UK7 stations, and J88AM. During the current month G4HZW reckons conditions weren't as good, although some Sporadic-E opening meant enjoyable EU contacts to occupy the band, and there is a Manchester net activity running through the day and on into night to keep the band in use. However, pre-rig-change QSOs were made on SSB with ZS1FH, GD3EIG who was *much* stronger than usual on July 8 along an 80-mile path, A4XIU, JY9RV,

CE6CDR, ZD8RH, CE2CNG, UL7PAE, C31WS, and on July 22, GM3OLK. By July 25 the new quad was up and the TS-820 installed, and GW4BLE was worked *via* Aurora. Then came EL2AG, C31NL, VE1AVR, KA1CVM, VE1AFR, K1EM, K1RM — the first Statesiders for some time — and G3MUV/CE0 on Easter Island, who, with RS55 reports both ways, finally decided Tony that the TS-820 just *had* to be bought! Then, as deadline time was approaching, came an evening when contacts with 5Z4RT, ZS1FH, ZE1AV, ZE1AR, and ZS6RA made the log look a bit fuller.

Now for the analysis of things from G3NOF (Yeovil). Don noted several opening to the States and South America around 2000, which he reckons were by Sporadic-E propagation, but otherwise all that G3NOF noted were Europeans and some dead days; CH2FOU (a special call for the Year of the Disabled) and 8P6GG were worked.

Nice to hear from Ted, G2HKU (Sheppey), who is now at least vertical again and able to hobble about, though at the time of his letter he wasn't yet back to work. Although overall the list of stations worked is much longer than usual, the only mention on Ten is of a CW QSO with the Argonaut to EA1AER.

Various interesting points crop up in the letters from G3ZPF (Dudley); Eighty wasn't very productive last time round, so David had to look at other things instead, and on the day before his letter there was a solar event (July 25) which flattened the bands for several days. Apart from the local Gs on their 28.325 kHz net frequency, PY2ZEZ was raised, and 5N9GM was a gotaway. David remarks that the Government had promised to legalise CB by August 1; and, as he says, week by week the number of CB-ers grows and the chance of gripping it becomes less — neither the modellers nor the amateur radio types have enough voice in the House.

Lots of things seem to have been happening to G4EZA who is now back in Colchester, and of course looking for work after all the studying is over. Meanwhile, there is DX, and construction — and repairing; the latter in the form of an el-bug which will send dashes or dots or even occasionally a continuous tone modulated by clock-pulse dots, so long as you *don't* touch the paddle! There is a new aerial mast (well, three lengths of timber bolted together!) rocking in the breeze and, propping the thing up at 25 feet, a 7 MHz dipole loaded up with the aid of an ATU on all bands 7-28 MHz. It found, on CW, JT0WA, LU4DEB, PY2VYR; and a beacon on 28.271 MHz signing U2ABJ, possibly Kaliningrad. SSB looked out to A9XDB, FP0FSZ, J73PP, VK6NLP, YV5BTS, and ZE1AR.

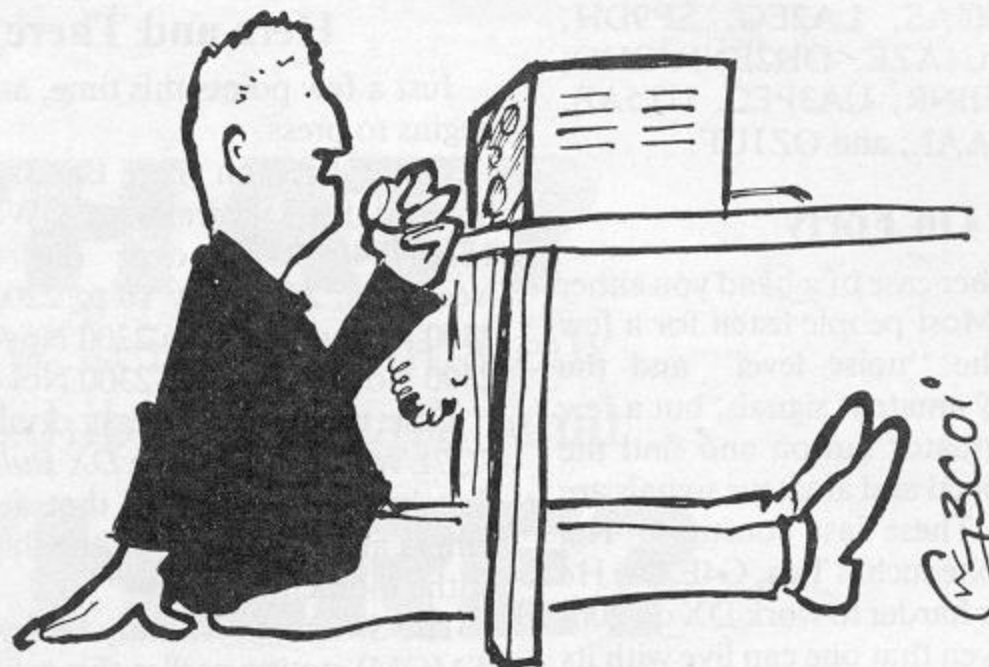

*"Oh you mean that sort of lower . . ."*

## Eighty

Followers of G2CAS's expeditions with the portable gear will be saddened to hear of the sudden death of John Douglas at the age of 73 years. G2CAS was operating as GM2CAS/P by the side of the Tweed at Coldstream only eight days before his death. He was a fine operator, and a great believer in persuading people to adhere to the Band Plans. Prior to his retirement he was a Lloyds Surveyor. He leaves a widow, a daughter and a son, to whom we extend our sympathy. Thanks to G2NJ for passing on the news to us.

G2NJ (Peterborough) mentions that up until about tea-time the band has been somewhat noisy and several have deserted it in favour of 7 MHz; but after that time it gave Nick some interesting bits — PA0CWF was worked from his home on July 4, and some days later G5CZI at Dartmouth was the same station on holiday in this country. July 1 saw an interesting four-way with G2BY (Ventnor), G3KPO and G6NZ/A (both these in Ryde, I.o.W.). Come to think of it, that is the first we've heard of G2BY for some little time — nice to know he's still active on the bands.

G2HKU stuck to CW, and in that mode he was quite able to snap up XT2AW and UA9CRP.

Another one to note the unreliability of Eighty was G3PKS, who says it was totally unreliable for daylight work after about 1000 for medium-range skeds, with sometimes sustained QSB to the point where one was in "black-out" conditions; switching of aerial feeder arrangements suggested that, apart from the absorption effect, there was some evidence to suggestion changes of polarisation as well.

## Top Band

This is where the game of DX-chasing seems to have different rules according to the sort of DX you chase, and the strength

of the signal you can put out. G3UUZ (Pendeen) might well have a good site for Top Band operation at his new lighthouse station, but there is so much to do on arrival at a new QTH; once all was beginning to look ship-shape and Bristol fashion domestically and a start made on the fitting-out of the shack, work came to a stop while the lighthouse was painted. But there looks to be a good signal from there when all is ready. And, it is noted, the junior op. has been showing interest in the R.A.E. exam., and the move has brought him to a school where one of the staff is a licensed amateur.

G4AKY (Harlow) continues his merry way, operating from around midnight for a couple of hours each night, but we hear rumours of the Law Being Laid Down (who dares to argue with the XYL?) and some thoughts of a modified procedure. Be that as it may, the results of his efforts for the month make a long list which we will have to prune a bit. In essence, all continents save Oceania were worked in normal "random" operating. Among the Europeans, C31HD, OH2BNP/OH0 and OJ0MA are a juicy enough trio, and there were lots of others of interest. Looking outside Europe, RG6GBX represented Asia; PY1CVR, PY1DMQ, PY1ZAE, PY2HDY, LU9EIE played for South America; EA8AK, EA9EU, ZD8TC for Africa, and VE1AXT for North America. In addition, ZS5LB is on the band, peaking about 0030z during July and usually heard around 1826 kHz, RST 349, and Dave has also been told, by G3SFT, that 5B4IC is about; G3SFT worked him on July 26, at 2045z when the 5B4 was RST 579 on 1839 kHz. We have heard tapes of some of these contacts as heard from the G4AKY speaker, and he certainly does seem to be raising them without too much trouble.

Now we turn to G2HKU, who offers his SSB sked with PA0PN, plus CW contacts with OJOAM, GM3IWS, GW3KOR, EI9J, LA9HW, PA3BFM, LA1EKO,



OL3BAQ, EI6AS, LA2EG, SP9DH, DL1HAX, YU1AZE, OH2BNP/OHO, 4U1ITU, SP6BNR, UA3PFC, UT5AB, LZ1CQ, UB5AAL, and OZ1UF.

### On Forty

This is another case of a band you either love or hate. Most people listen for a few minutes to the "noise level" and the absence of any amateur signals, but a few press the attenuator button and find the noise has dropped and amateur signals are now audible. These last constitute The Faithful, and one such is Tim, G4EZA. He reckons it is far harder to work DX on 20m than Forty, given that one can live with its timescale and given that the station we are talking about is basic like Tim's with a dipole hung at the middle from a 25-foot pole. His argument is fairly simple: on 14 MHz, any DX putting a call out will get 14 (or more) replies among which our man is well down the pile due to his aerial. On the other hand, the 7 MHz QRM is just that — the YL on Tirana Radio isn't suddenly going to set up against you in the DX chase. Thus, on Forty it is much more nearly true to twist the old adage and say that what you can hear you can work. G4EZA mentions CW to AI2Q, CM2AE, CM2PE, OH0NA, WB2WSN, W3GOH, and W8DVY who was running a TS-520 into an eight-foot whip.

Next we turn again to another Believer, G2HKU, who tried it all ways this time; SSB to LX1KE, I0JU/IS0, G4LBK/MM (the yacht *Biscuit* single-handing it to the U.S.A.), G2HCG/MM — the *J-Beam* man — motor-cruising in *Fair Folly* in the Solent, plus CW to OJ0AM, UM8PAC, F0GAE/FC; and then QRP SSB went out to PA0AUV, LX1KE, ON4WD, and C31NL.

G3PKS noticed how, during the day, a hefty G station would sink below audibility, replaced by an equally hefty European; a few moments later the EU would start to sink to inaudibility and be replaced by the G again. Very confusing to all. He also noticed what he thinks might have been phase distortion on some of the weaker SSB signals, making them difficult to tune, and wonders whether the effect could also appear on CW signals — although Jack does wonder whether *his* wandering CW signals may not be a function of the old HW-101 which has just been revalved. A complication is that the effect isn't always there.

Last time around, G3ZPF mentioned his Apple program for SS/TV; this time he is able to say he has used it, and finds it works better than the one he already had, but not quite as well as the result on the Robot SS/TV converter. Nonetheless, David found a few QSOs on the mode made a change in the operating routine. On Forty, and being more specific, R05OM was raised on CW, and on SSB there were lots of Gs plus a few GMs and EUs.

### Here and There

Just a few points this time, as the space begins to press.

Those LAs on Top Band. They are licensed for ten watts of CW, between 1810-1840 kHz, over the following weekends: 2200 July 10 to 2200 July 12, 2300 November 13 to 2300 November 15, 2300 November 27 to 2300 November 29.

Last time out we cast doubt on the 7Q7LW station, but the *DX Bulletin* has it that he is genuine, and that a couple of others are also licensed though not active at the moment.

The Sovereign Military Order of Malta (SMOM) station earlier this year seems to be having a bit of a struggle in getting past the DXCC criteria — it would appear that such as the Vatican or UN Hq building in Manhattan would not get by under the present standard. Odd, ain't it — a bit of sand that dries out at low water counts as a country for DXCC, but a *country* doesn't.

Those wanting San Felix should keep an anxious ear to the usual DX frequencies for CE0X during September; he leaves on September 11 and should be operational within 48 hours.

### Twenty

Many readers will know of your conductor's dislike for early rising, and will therefore be somewhat surprised to hear him say that twice during the period under review he has heard the sked with DL8FL and VR6TC on Pitcairn.

G4EZA found OJ0AM on CW, plus SSB to TI2CF and CT2ARA.

At G2HKU SSB latched on to VK3PX, ZL1VN, ZL3SE, ZL3FV and OY6FRA, while the CW connected him to KH6IJ, UD6DLL, and OJ0AM. Turning to the QRP, the Argonaut was keyed to raise HA4XR and OJ0AM. Conditions were rather erratic with sudden fades on the ZL long-path skeds, these being from S8 to S2 in a fraction of a word.

A slightly longer list comes in from G3ZPF, who offers his CW QSOs with HS5AID, K1ZZ, WD4HFV, UK6AAD, DL8YU/M, HB9BUU/M, UP2BGV, TF3YH, UA9OEL, and OY1R as a gotaway. As for SSB, CS0OF (a special for CT1) and OH0OT were worked.

The early mornings have been the best, from 0600, reckons G3NOF, with the VKs being heard most days albeit sometimes only for short periods; on other days the skip has been to W6/W7 and the Pacific, and/or KL7. Conditions weren't so bright during the day and not much DX was about during the evenings. SSB QSOs were made with AX3AH (a special prefix for the Royal Wedding), FY7BB, GU5DYP, GU5DYQ, HH0N (Navassa), HR1EHA, J6LT, JX5VAA, KH6HHD, KL7G, KL7L, KL7Y, NL7J, NL7L, OJ0AM, P29FV, VE1BL/1 (St. Paul Is.), VKs, VP2VGI, VR6TC, XB1OX,

XT2AU, W6s, YS9LOC, ZLs, and 5R8AL.

### Fifteen Metres

Now let's take G3NOF first; Don says he has listened a lot on this band, and found it subject to quite deep fading with frequent dead periods, and he also noted a noise like waves on a beach which he confirmed as being heard world-wide. In general conditions have been not so good as last year. Around 0700z there have been some openings to the Pacific, KL7, W6, W7 on the long path; and around 1100 the short path to H44, VK9, and P29 was open, but not for long, while East Coast Ws were also heard at this time, again not for long. Then, around 1700, the odd West Coast W, with the East Coast Ws back around 2100 and on until the small hours. SSB QSOs were made with A4XIH, A4XID, A7XD, AI6V, C31WW, DK2XN/TZ, DK3SN/KP2, EP2TY, F0CH/FC, FG7BR, FO0FB, FY7AN, G3KTC/MM in the S. Atlantic, GB2TDF, H44CF, HC8KA, HH0N (Navassa), HT1PCR, I2DMK/ID9, JAs, JT0WA, KH3AB, KH6JUJ, KL7Y, M1D, N7DF, OJ0AM, OH0AM, TA8BE/TA1, P29NCB, PYs, UA3TDX/U6F, VE1BL/1 (St. Paul Is.), VK9NYG, VP2MDG, VP5EE, VP8ZR (South Orkneys), W4MAT/SV5, W6s, W7KW, W7WHB, WH8AAJ, YB0TD, YJ8NPS, ZS1FJ, 3D2CS, 5N3HGP, 6W8AR, 7P8BJ, 9G1AP, 9G1RT, 9K2DR, 9M2DW, and 9V1W.

G4LDS mentions A4XIJ, and a string of JAs in the log; in the IARU contest a mixed bag, like VE7SK, JA1, JA7, then Europeans until VE7TAR came up for a chat and to compare notes, then an hour or so later EL2AV, SV0AN, W1, KP4BZ (this one possibly a W4), then W1, W4, W5, W8, plus DU1CPL for tea, and the next KW4T — these funny W prefixes do confuse one. After that there were a couple of ten metre QSOs before as already mentioned, the rig turned its toes up.

G3ZPF stuck to his CW, and it resulted in UT5VG, UA6AJO, PY2TU, KA9DFI, and WA8UHK.

And that, dear readers, is the lot!

### Finale

Keep up the good work: these extra reports make it so much easier to draw a rounded picture of events — the more the merrier. If we can find space next time we'll run some QSL addresses as well. Meanwhile, the deadline is in the 'box' and your letters addressed to "CDXN", SHORT WAVE MAGAZINE, 34 High Street, Welwyn, Herts. AL6 9EQ. By then we might be seeing the beginnings of the autumn upturn too; but for now, 73 es DX.



## WHAT?

The NEW Leicester Amateur Radio Exhibition. That's what.

## WHERE?

The Granby Halls, "as usual," but with improved facilities including new catering arrangements, easier car parking and quicker admission. That's where.

## WHEN?

Friday, Saturday, Sunday, 23, 24, 25 October 1981, 10am-6pm Fri/Sat, 10am-5pm Sun. That's when.

## WHO?

At this independent show you will find some of the best-known retailers in the country. You will also find many specialist traders not previously invited to participate at Leicester. This way you'll have a real chance of finding the rig you want – at a keen price too – and also some of those awkward bits and pieces you're always looking for and can never track down. That's who you'll see there.

## WILL THEY SEE YOU?

With talk-in on 2m and 70cm you can't lose your way!

**SPECIAL ATTRACTION**  
BRING AND BUY TO BE RUN  
BY THE LEICESTER AMATEUR  
RADIO CLUB.

# MAIL ORDER

FROM



# AMCOMM



by two way  
**FREEPOST**

MORSE KEYS		
HK 707	Straight Up/Down keyer	£11.44
BK 100	Semi-automatic mechanical bug	£17.88
MK 702	Up/Down keyer on marble base	£22.43
MK 702	Manipulator	£22.43
MK 704	Squeeze paddle	£14.38
MK 705	Squeeze paddle on marble base	£22.43
EKM 1A	Morse code practice oscillator	£8.63
MK 1024	Automatic memory keyer	£135.13
EK 150	Semi/Automatic keyer	£74.75

LINEAR AMPLIFIERS		
2M10-80P	144MHz 10W input/80W output with 9dB preamp	£138.00
2M25-150P	144MHz 25W input/150W output with 9dB preamp	£184.00
2M10-150P	144MHz 10W input/150W output with 9dB preamp	£209.88
2M3-150P	144MHz 3W input/150W output with 9dB preamp	£209.88

G. WHIP Mobile Antennas		
Tribander 10-20 Slide		£25.88
L.F. Coil 40/80/160 MTS		£6.56
L.F. Whip Telescopic		£4.26
Multimobile 10-20 Auto		£30.48
M/Mobile Coil 40/80/160		£6.56
M/Mobile Whip Telescopic		£4.26
Flexiwhip 10M Mast		£18.11
F/Whip Coils 40/80/160		£6.56
Base Standard		£6.00
Base Heavy Duty		£6.50
Extenarod		£12.00

SHURE MICS		
201	Hand ceramic omnidirectional high impedance	£14.49
202	Hand ceramic noise reducing high impedance	£15.18
401A	Hand controlled magnetic high impedance	£16.56
401B	Hand controlled mag. low impedance (200 ohms)	£16.56
444	Desk adjustable height controlled magnetic	£32.43
526T	Desk controlled response transistor preamp	£39.33

DUMMY LOADS		
DL20	30W DC-150MHz with PL259 connector	£6.33
T-80	80W DC-500 MHz with SO239 connector	£22.94
T-150	150W DC-500MHz with SO239 connector	£32.78

**STILL HELPING WHERE IT HURTS**

Here's a list below to make buying easier for you — Work it out yourself — You'll see — It really is easy!

Product	List Price	Deposit	12 Payments
Yaesu FT 902DM	£799	£312	£40.55
Yaesu FRG 7700	£309	£119	£15.89
Yaesu FRG 7700M	£389	£160	£19.01
Yaesu FRG 7000	£299	£115	£15.30
Yaesu FT 101ZD FM	£599	£250	£29.05
Yaesu FT 101ZD AM	£585	£225	£30.02
Yaesu FT 101Z FM	£529	£190	£28.27
Yaesu FT 101Z AM	£515	£195	£26.61
Yaesu FL 2100Z	£385	£155	£19.20
Yaesu FT 225RD	£565	£220	£28.76
Yaesu FT 707	£529	£200	£27.49
Yaesu FT 480R	£359	£175	£15.30
Yaesu FT 290	£229	£100	£10.82
Standard 8800	£252	£99	£12.71
Standard C78	£219	£99	£10.04
Standard C58	£247	£107	£11.69

Many Other Items Available on Similar Terms  
Call for Details

MICROWAVE MODULES	
MMT 432/28S	£149.00
MMR 432/144R	£184.00
MMT 28/144	£199.00
MMT 144/28	£99.00
MMC 28/136	£27.90
MMC 28/156	£27.90
MMC 28/144	£27.90
MMC 144/any IF	27.90
MMC 144/28LO	£29.90
MMC 70/any IF	£27.90
MMC 432/28S	£34.90
MMC 432/144S	£34.90
MMC 1296/any IF	£32.20
MMC 050/500	£69.00
MMA 28preamp	£14.95
MMA 144V preamp	£34.90
MMV 1296/28	£32.20
MML 144/100linamp	£142.60
MML 432/100linamp	£228.85
MML 144/25linamp	£59.00
MML 432/50linamp	£119.00
MM 2000	£169.00

UNADILLA/REYCO	
Antenna Traps — Precision moulded coil forms stainless - hardware - Aluminium tube irridit finish - Coated aluminium wire. Fully waterproofed.	Available 7/14/21 MHz <b>£11.99</b>
W2AU BALUN	
3.5/30 MHz 2.5 Kw with Lightning Arrestor — Suitable Vees, Yagis, Doublets, Quads, etc.	<b>£11.99</b>
STANDARD	
C8800 2m Tcvt	£252.00
C7800 70cms Tcvt	£275.00
DENTRON	
GLA 1000 Linear Amp 10/80 1Kw	£295.00
MLA 2500 Linear Amp 10/160 2Kw	£699.00
MT 3000 3Kw Tuner/SWR/Dummy Load	£275.00

FDK Multi 700EX	£199.00
FDK Multi 750E	£299.00
Send 30p for our bumper bundle literature	
No Quibble Guarantee Same Day Despatch All Items Advertised	

Choose your AMTECH here	
Amtech 100 Mobile Match	£16.95
Amtech 200 Random Wire ATU 10-160m 200w pep	£29.95
Amtech 300 Random and Coax Fed ATU 300w pep	£43.95
Amtech CW 250 — The most outstanding CW filter available	£24.90
Amtech Channelguard — A plug in device to eliminate those unwanted stations	Decoder £15.25 Sender £7.25
Amtech FM7: FM Demodulator for FRG 7	£11.90

SWAN CUBIC	
Astro 103	£799
PSU	£139
1500Z linear	£399
ST1A ATU	£134
ST2A ATU	£173
ST3ATU	£122

**USED EQUIPMENT**  
Over 100 pieces HF/VHF equipment available. Call for details.

ANTENNAS	
Wide range in stock including JAYBEAM — HYGAIN — CUSHCART — ASP TELECON — HOKUSHIN etc.	
Bantex 5/8 mobile whip complete antenna	£8.99
Bantex 1/4 w mobile whip complete antenna	£3.50

ROTATORS	
Skyking SU 4000	£92.00
Skyking 250	£39.50
Emoto 502CXX	£139.75
KR 400RC	£90.85
AR 40	£59.00
KR 950 2A	£50.00
Rotor Bearing	£12.00

SWR/RF POWER METERS	
SWR 25 3.5/170 MHz	£12.94
LEADER LPM 885-HF 1Kw	£58.00
HANSON 3.5/150MHz 200w	£28.75
REECE UHF 74 144/432	£16.28
HANSON FS 500H 1.8/60MHz 2Kw	£67.85
OSKAR SWR 200 3.30 MHz 2Kw	£40.00

**NO POSTAGE REQUIRED**

**AMCOMM SERVICES (S1), FREEPOST, HARROW HA2 0BR.**

Please send me .....

at .....enclosed cheque/P.O. for .....

.....or charge my VISA/ACCESS

Nr.....

Name .....

Address .....

.....Post Code.....

# AMCOMM SERVICES

194 NORTHOLT ROAD, SOUTH HARROW, MIDDX.  
Telephone: 01-864 1166, 01-422 9585  
Opposite South Harrow Tube Station on Piccadilly Line

**Showroom Opening Hours**  
Tuesday to Saturday 9 — 5.30  
Sunday by Appointment

All items over £100 available on easy terms at List Price

# RADIO SHACK for THE BEST OF EVERYTHING IN AMATEUR RADIO

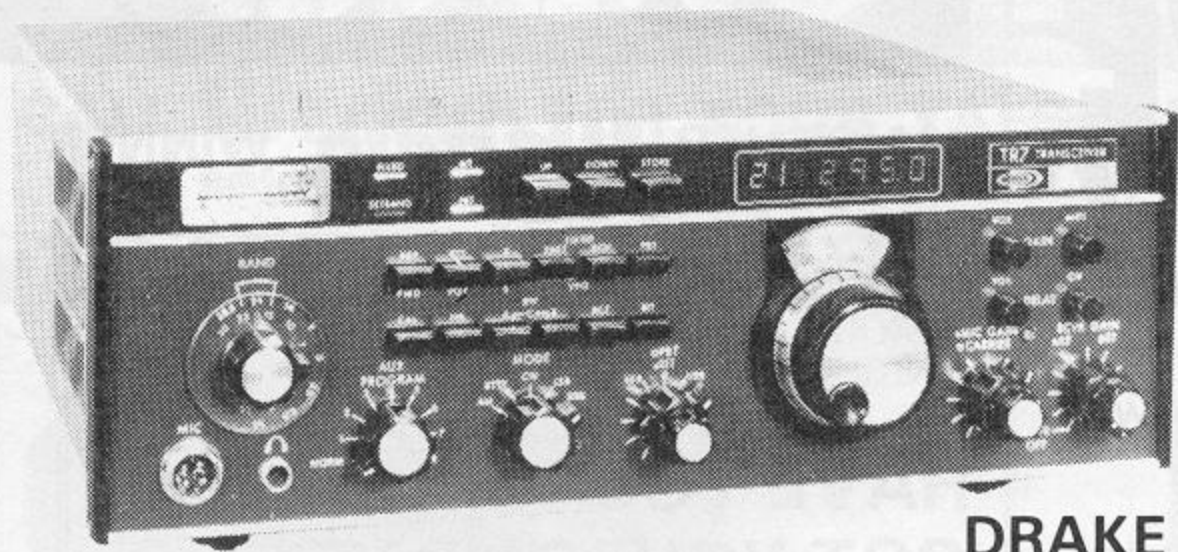

**DRAKE**

**TR-7 TRANSCEIVER, R-7 RECEIVERS, AND ALL ACCESSORIES**

**HY-GAIN ANTENNAS  
HUSTLER ANTENNAS  
CDE ROTATORS**

**BEARCATS**

*With 4m, 2m &  
70cm FM  
Amateur Bands*

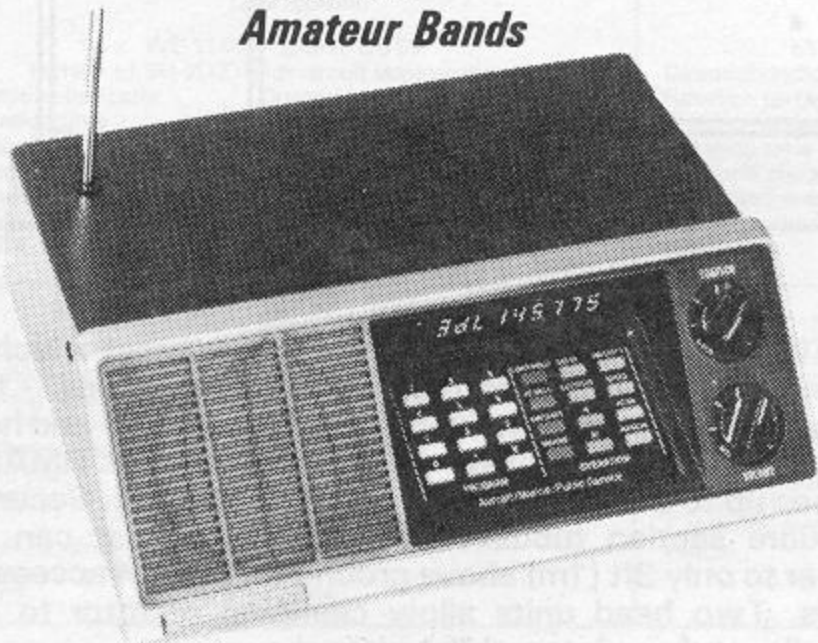

**COLLINS KWM-380 TRANSCEIVER**

**AVANTI ANTENNAS  
TRS-80 COMPUTERS  
VIDEO GENIE  
HAL RTTY EQUIPMENT  
J-BEAM ANTENNAS  
ASTATIC MICROPHONES  
TELEX HEADPHONES**

**HAVE YOU  
GOT YOUR  
RADIO SHACK  
CHARGE CARD  
YET?**



**TRIO HF  
& VHF  
RECEIVERS &  
TRANSCEIVERS**

**LOTS & LOTS  
MORE**

**MACROTRONICS RTTY — TEN-TEC  
AEA MEMOMATIC KEYERS,  
BENCHER PADDLES, VIBROPLEX**

**(ONE DAY WE MAY EVEN  
HAVE EVERYTHING  
LISTED!!!)**

**ACCESS ★ SALES ★ SERVICE ★ BARCLAYCARD**

**RADIO SHACK LTD.**  
188 BROADHURST GARDENS, LONDON NW6 3AY

Giro Account No. 588 7151 Telephone: 01-624 7174 Cables: Radio Shack, NW6 Telex: 23718

TRIO



LAR

AUTHORISED  
ICOM  
DEALER

# SHORT WAVE 'GOOD BUYS'

Buy from the Short Wave Specialists every time ... you'll get good service from professionals who know your hobby well. For example:



R1000 Communications Receiver for use at home and in your boat or caravan  
PRICE

**£ 305.90**

SX200N Scanning Receiver 26 MHz to 512 MHz  
PRICE

**£ 264.00**

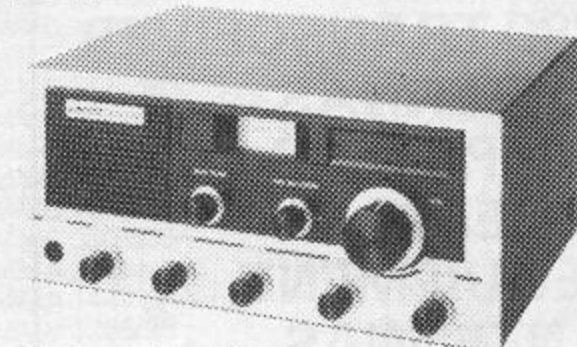

SRX 30D. The most popular Short Wave listeners receiver. 0.2 - 30 MHz now with digital readout!  
PRICE

**£ 195.00**

Buy by post - or 'phone your Barclaycard, Access or LAR Creditcard number. Alternatively, call in for a chat. The shop is just 10 minutes from Leeds City Station and there's easy parking if you travel by car. \*Instant HP for licensed Amateurs. \*Extended Credit Terms Available. **A QUOTATION ON ALL CREDIT ITEMS IS AVAILABLE**  
\*Open Mon-Fri 9.15 - 6.00 pm, Saturday 9.15 - 5.30 pm

LAR

Leeds Amateur Radio  
27 Cookridge St., Leeds, W. Yorkshire. LS2 3AG.  
Tel: (0532) 452657 (Shop).  
Mail Order/Service Department: 60 Green Road, Meanwood, Leeds LS6 4JP. Tel: (0532) 782224

## POST NOW!

Send 50p for Catalogue and Price List.

I enclose cheque for £ \_\_\_\_\_ Plus 50p for Brochure\*  
\*delete if not applicable.

to purchase

Name \_\_\_\_\_

Address \_\_\_\_\_

SW1

Post to: Leeds Amateur Radio, 60 Green Road, Meanwood, Leeds LS6 4JP.

TO BARCLAYCARD/ACCESS/LAR

I authorise you to debit my Barclaycard/Access/  
LAR Budget Account with the amount of £ \_\_\_\_\_



My No. is

Signature \_\_\_\_\_

TRIO DISTRIBUTOR, LAR are area distributors for CUSHCRAFT, Antenna Specialists, ICOM, Microwave Modules.

# Western

ANOTHER **Western** WINNER

## The 30ft ULTIMAST

HAVE YOU  
GOT YOURS UP YET?

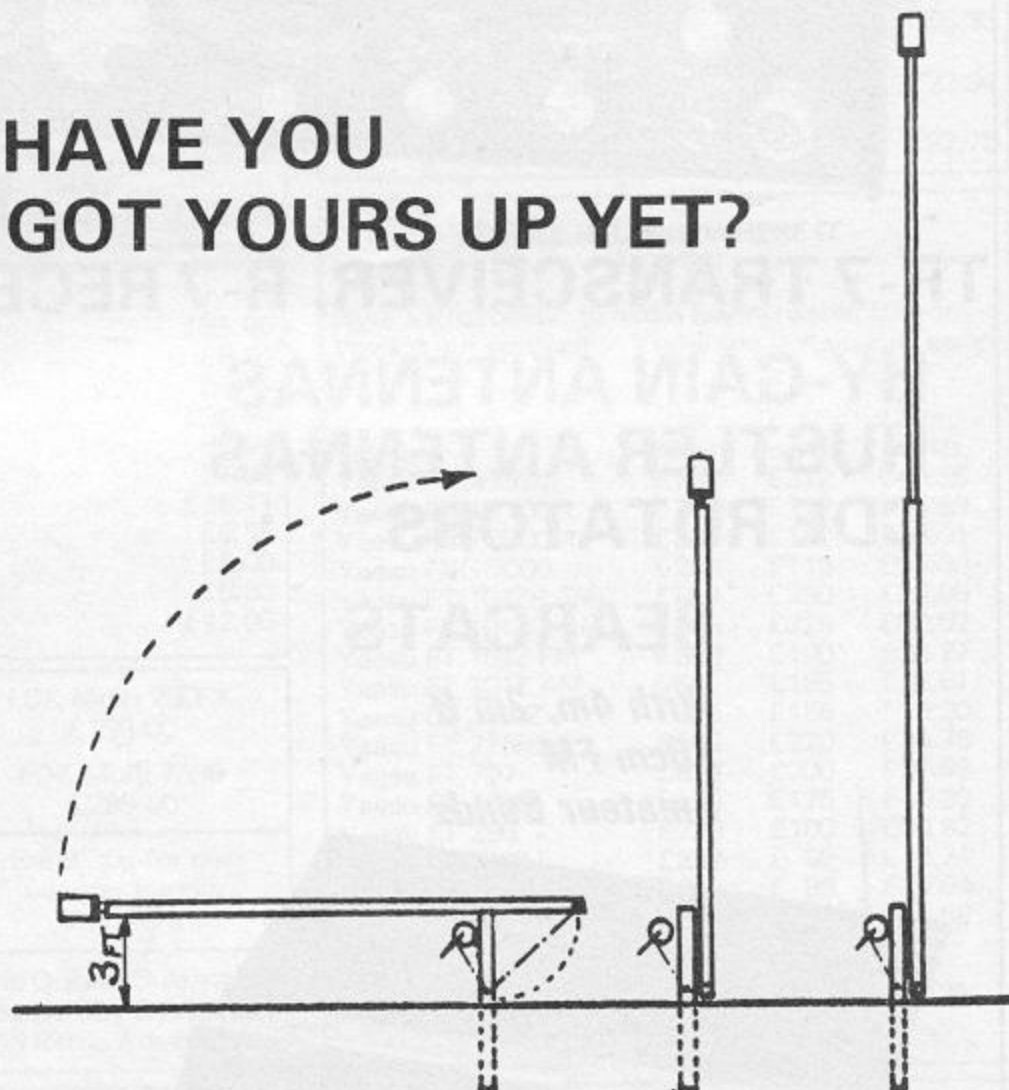

The ULTIMAST is a tubular steel two-section mast which is telescopic and tilt-over. Constructed of two steel tubes - the lower square section and the upper round section - and hot-dip galvanised for corrosion resistance, the ULTIMAST telescopes up to 30ft (9m) and down to 15ft (4.5m). Secured to a square section tubular base post, the mast can be tilted over to only 3ft (1m) above ground for ease of access to antennas. Two head units allow clamping of rotor to 2" (50mm) dia. stub, or internal flat plate mounting.

- ★ Slim and unobtrusive
- ★ One-winch operation
- ★ Simple ground fixing
- ★ Self-supporting
- ★ For HF and VHF antennas

COMPLETE TELESCOPIC  
TILT-OVER MAST UM-1;  
UHD-2 for only

**£ 246.05**

FULL PRICE LIST

UM-1 Basic mast	£215.00
UHD-1 Reducing head adaptor	£ 13.25
UHD-2 Rotor head unit	£31.05

All prices include carriage and VAT at 15%  
For Scotland - add £10 extra carriage

## Western Electronics (UK) Ltd

HEAD OFFICE (All Mail/Enquiries)  
FAIRFIELD ESTATE, LOUTH, LINCS LN11 0JH  
Tel: Louth (0507) 604955 Telex: 56121 WEST G

# Electronics (UK) Ltd

CALL **Western** FOR YOUR YAESU AND TRIO REQUIREMENTS  
A selection from the range . . .

## YAESU FT-101ZD

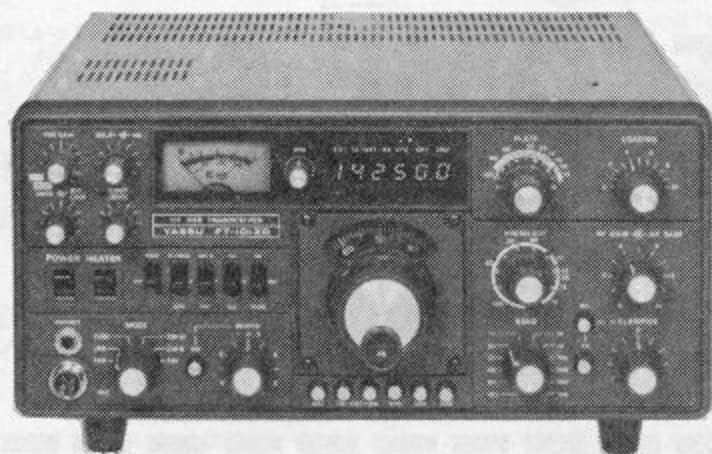

FROM  
**£575**  
(Dep. on  
Model)

The FT-101 series needs little introduction. Suffice it to say that the latest FT-101Z (analogue) and FT-101ZD (digital) transceivers represent a first-class continuation of a fine line of HF equipment. The latest technology brings you top performance at a price you can afford. Full details of this exciting transceiver available on request. WARC bands fitted, of course!

## TRIO TS-830S £699



The TS-830S is a high-performance, very affordable, HF SSB/CW transceiver with every conceivable operating feature built in for 160 through 10 metres (including the three new bands). The TS-830S combines a high dynamic range with variable bandwidth tuning, IF shift, and an IF notch filter, as well as very sharp filters in the 455kHz second IF.

ALSO AVAILABLE: TS-530S at £539

## A FULL RANGE OF ANTENNA ROTORS from **Western**

### THE "BUDGET" FAMILY (24v motors)

WE-1145 — LIGHT DUTY (similar to SU-2000 with circuit improvements)	
Direction indicator	Control knob
Rotation time	60 seconds
Antenna weight (max)	50 kg
Mast size	28-44 mm
Wind load area (max)	0.25 sq. m.
Cable required	5-way
PRICE	<b>£34.95</b>

### "EMOTO" — THE "PROFESSIONAL" FAMILY (All EMOTOS take 32-62 mm mast — motor volts 50-0-50v isolated)

EMOTO 103SAX — MEDIUM DUTY	
Direction indicator	360° circular dial
Rotation torque	450 kg. cm.
Braking torque (stationary)	1500 kg. cm.
Rotation time	55 seconds
Antenna weight (max)	150 kg
Wind load area (max)	0.5 sq. m.
Cable required	6-way
PRICE	<b>£86.25</b>

EMOTO 502SAX — HEAVY DUTY	
Direction indicator	360° circular dial
Rotation torque	600 kg. cm.
Braking torque	4000 kg. cm.
Rotation time	66 seconds
Antenna weight (max)	400 kg
Wind load area (max)	1.5 sq. m.
Cable required	6-way
PRICE	<b>£125.35</b>

FU-400 — MEDIUM DUTY	
Direction indicator	Meter (NESW)
Rotation torque	550 kg. cm.
Braking torque (stationary)	1500 kg. cm.
Rotation time	60 seconds
Antenna weight (max)	200 kg
Mast size	38-50 mm
Wind load area (max)	0.5 sq. m. (basic) 0.8 sq. m. (with stay bearing)
Cable required	6-way
Lower mast clamp included	
PRICE	<b>£64.95</b>

EMOTO 1102MXX/1103MXX — EXTRA-HEAVY DUTY	
Direction indicator	Meter (NESW)
Rotation torque	800 kg. cm. (1102); 1000 kg. cm. (1103)
Braking torque (stationary)	10000 kg. cm.
Rotation time	80 sec. (1102); 110 sec. (1103)
Antenna weight (max)	400 kg
Wind load area (max)	2.5 sq. m.
Cable required	7-way
PRICE	1102MXX <b>£189.75</b> 1103MXX <b>£194.35</b>

EMOTO ACCESSORIES		
1211	— Mast bracket for 103SAX	<b>£10.93</b>
1213	— Mast bracket for 502SAX	<b>£14.38</b>
1215	— Mast bracket for 1102/1103	<b>£22.43</b>
MB-300	— Rotary guy bearing	<b>£13.80</b>

## STATION ACCESSORIES

### POWER/SWR METERS

Osker SWR-200 (3.5-150MHz)	<b>£42.95</b>
Welz SP-300 (1.8-500MHz)	<b>£75.00</b>

### PEP WATTMETERS

Western PM-2000 (3.5-30MHz)	<b>£51.75</b>
Western PM-2001 (50-150MHz)	<b>£51.75</b>

### ANTENNA SWITCHES (SO-239 sockets)

2-way W-202	<b>£7.95</b>
5-way ASW-1	<b>£11.15</b>

### NEW IMPROVED DUMMY LOAD

300 watts continuous 1 kW intermittent (finned, air-cooled type — no oil to leak) **£39.95**

## SPECIAL OFFERS!

### ALL BRAND NEW STOCK

Trio TS-820S	<b>£559</b>
Yaesu FT-720RV	<b>£239</b>
Yaesu FT-720RU	<b>£269</b>

★★Both 720's include FREE 4m extension cable★★

Phone/call/write for full  
SPECIAL OFFER LISTS



**AUTHORISED DEALERS**

FULL DETAILS ON REQUEST



## "TANTEL" PRESTEL ADAPTOR

(GPO APPROVED)

ONLY

A HIGH QUALITY, LOW-COST ADAPTOR — NEEDS PHONE JACK AND YOUR OWN T.V.

**£199**

ACCESS — VISA CARDS ACCEPTED — HP ARRANGED (WRITTEN QUOTATIONS ON REQUEST)  
ALL LISTED PRICES INCLUDE VAT AT 15% AND CARRIAGE

## Western Electronics (UK) Ltd

FAIRFIELD ESTATE, LOUTH, Lincs LN11 0JH

Tel: Louth (0507) 604955 Telex: 56121 WEST G

OPENING HOURS: 09.00-12.00; 13.00-17.00 Mon/Fri; Saturdays 0900-1700

NORTHERN IRELAND  
Mike Matthews, G18MNO  
Newtownards (0247) 815859

SOUTHAMPTON  
Alan Paxton, G4BIZ  
Southampton (0703) 582182

LEICESTER  
May's Hi-Fi, Churchgate  
Leicester (0533) 58662

# 'DATONG'

## THE INNOVATORS...

### KEYBOARD MORSE SENDER

Historically the electronic key superseded the straight key for the simple reason that it reduces sending fatigue by reducing hand movements.

But progress continues. There are now at least four good reasons why the Datong Keyboard beats an electronic key. First, it reduces hand movements even further. Second, it cuts the need for mental concentration so you can save the effort for receiving (a task for which the brain is uniquely suited). Third, learning to use it is very easy and it's a useful skill anyway (unlike "padding" or "pumping"). Fourth, even a beginner can reliably send error free morse, and remember that good morse means better copy.

Now check the summary below to see why the Datong Keyboard beats other keyboards

- **CONVENIENCE:** no need for a power cable, four internal pen cells last for 300 hours and give continuous memory back up.
- **EXCLUSIVE COLOUR CODED KEYBOARD DESIGN:** Separate key switches beneath a tough polycarbonate membrane combine excellent "feel" with a splash proof wipe-clean surface.
- **LAVISH MEMORY:** four 64-character memories with auto-repeat and programmable "pause" function, for all the routine sending.
- **BUFFER MEMORY:** ensures perfect sending despite less than perfect typing.
- **COMPREHENSIVE CHARACTER SET:** includes punctuation, procedure signals, accented letters. Plus a "merge" key for making any non-standard character.
- **BEAUTY AND STYLE:** only one inch thin and with four-colour panel Model MK looks every bit the thoroughbred it is.

Model MK is supplied with output leads and spare connectors but without batteries (four HP7 pen cells).



Model MK

### GB's - ARE YOU MISSING OUT?

Unless you can monitor the other bands you are missing a lot. If you have a 2 metre all-mode receiving set up, just add Model PC1 in series with its antenna and you have a superb general coverage receiver. What better way to listen in to all the non-VHF amateur bands, not to mention everything else from 60 kHz to 30 MHz? For sheer value for money there is no better way to get high performance general coverage reception. After all what a waste it

is if your expensive 2 metre all-mode rig covers one band only? **ATTENTION VHF SCANNER OWNERS!** Did you know that Model PC1 will extend the coverage of your SX 200 type scanner to include all the long, medium and short wave bands as well? This is an excellent way to listen to your favourite short wave broadcast stations without the extra expense of a complete new receiver.

### MINIATURE RECEIVING ANTENNAS

If you don't have enough space to put up traditional receiving antennas, our active antennas are the answer. They need no tuning yet have constant sensitivity from 200 kHz to well over 30 MHz. Results are quite comparable to full size conventional antennas but the space saving is enormous. The indoor version (AD270) is 3 metres long and the outdoor version (AD370) is 2 metres long.

A TV-type feeder cable of any reasonable length can be used yet because the antennas are balanced dipoles any interference picked up by the feeder is rejected. Because of their wide frequency coverage Datong Active Antennas are ideal accessories for modern general coverage communications receivers.

Model AD370



Model DC144/28

excellent combination of low noise figure and strong signal handling capability. Its input and output gain controls also help you get the best out of your main receiver without flattening it with excessive gain. Model DC144/28 is available either as a complete cased unit (die cast box, S0239 connectors) or as a ready built and tested PCB module.

### YET ANOTHER 2 METRE CONVERTER?

Yes but not just another. Model DC144/28 is designed to overcome the overload and spurious signal problems experienced by conventional converters. It uses a Schottky diode balanced mixer with about 7dbm of local oscillator drive. This, coupled with a 3SK88 r.f. amplifier, gives an

**MODEL ASP - THE "INTELLIGENT" RF CLIPPER** Model ASP modifies your speech signal direct from the microphone and makes it more effective at modulating your transmitter. The effect is as if the transmitter peak power were to increase by between two and three times. "Intelligent" means that unlike other speech processors Model ASP automatically senses your voice level and reacts accordingly to always maintain the degree of true r.f. clipping selected (in decibels) by the panel push-buttons. Special circuitry does this without the undesirable side effects of simple a.g.c. devices. Adding a Datong r.f. clipper to a normal SSB transmitter has a similar effect to adding a linear amplifier but without the high cost and risk of TVI.



Model ASP

### MODEL D70: THE GO-ANYWHERE MORSE CODE TRAINER

For building up your morse code reception speed there is no better method than the Datong "Morse Tutor". You learn the code with the characters at normal speed but with an extra delay between each one. As you improve you reduce the "DELAY" control until, with it fully reduced, you find you are reading code at the chosen speed and with correct spacing.



Model D70

An important feature is that the unit is completely portable. This allows you to practise wherever and whenever you find it most convenient. The all-CMOS design gives about 60 hours of practice from a lowcost PP3.



Model FL1

### IMPROVE YOUR SELECTIVITY

Model FL2 transforms the selectivity of your receiver yet simply connects in series with the loudspeaker. It contains three high performance audio filters (lowpass, highpass and notch) which can be used separately or together to give optimum

results for any mode and any conditions. Since, with most receivers, the built-in selectivity is a compromise, adding Model FL2 can greatly improve your ability to reject interference from overlapping SSB or CW stations. Model FL1 works in a similar way but has the unique feature of being able to notch out interference whistles automatically. The cost of a Datong audio filter is little more than the cost of a single accessory crystal filter, yet in terms of versatility and performance the audio filter is far superior.



Model FL2

### Products not shown in this advertisement

- Model Datest 1 Transistor Tester
- Model Datest 2 Transistor Tester
- R.F. Speech Processor Model D75
- Model RFC/M.R.F. Speech Processor PCB Module
- Model MPU, Mains Power Unit
- Accessory Leads
- Model VLF



## INGENIEURBÜRO ULRICH HANSEN

### VHF & UHF PREAMPLIFIERS: A range from Ulrich Hansen of West Germany

A range of high quality in-line preamplifiers for 2 metres or 70 cms. featuring ultra-low noise figures and state-of-the-art design. The range includes R.F. switching capability from 60 watts P.E.P. to 500 watts P.E.P. and choice of silicon low noise devices or the latest gallium arsenide MESFETs for the best possible noise figure. Indoor or mast mounted options are also included. Full details free on request. These units represent a cost-effective way of improving your DX receiving capability.

PRICES: All prices include delivery in U.K. basic prices in £ are shown with VAT - inclusive prices in brackets.

FL1	59.00 (67.85)	VLF	22.00 (25.30)	AD270	33.00 (37.95)	MPU	6.00 (6.90)
FL2	78.00 (89.70)	D70	43.00 (49.45)	AD370	45.00 (51.75)	DC144/28	31.00 (35.65)
PC1	105.00 (120.75)	D75	49.00 (56.35)	AD270 + MPU	37.00 (42.55)	DC144/28 Module	25.00 (28.75)
ASP	69.00 (79.35)	RFC/M	23.00 (26.45)	AD370 + MPU	49.00 (56.35)	Keyboard Morse Sender	140.00 (161.00)

**DATONG ELECTRONICS LIMITED**  
Spence Mills, Mill Lane, Bramley, Leeds LS13 3HE, England. Tel: (0532) 552461

# Conquer the chip!

The silicon 'Chip', the microprocessor, and the whole field of modern electronics will revolutionise every human activity over the next decade . . .

If you are looking for a new job or career, promotion, your own business or simply want to keep abreast of modern developments - you will need to master the subject. It can be done simply and efficiently, in a practical way. No previous knowledge is needed. Write to us now - without the slightest obligation. . . . We have been successfully training people in electronics, at home, for over 40 years!



## MASTER ELECTRONICS LEARN THE PRACTICAL WAY BY SEEING AND DOING

- Building an oscilloscope. • Recognition of components.
- Understanding circuit diagrams. • Handling all types Solid State 'Chips'.
- Carry out over 40 experiments on basic circuits and on digital electronics.
- Testing and servicing of Radio, T.V., Hi-Fi and all types of modern computerised equipment.

## MASTER MICROPROCESSORS

LEARN HOW TO REALLY UNDERSTAND MICROPROCESSORS, HOW THEY WORK AND THEIR APPLICATION TO COMPUTER TECHNOLOGY.

- Complete Home Study Library • Programming
- Special Educational Microprocessor Equipment supplied
- Services of skilled tutor available throughout course

## MASTER THE REST

- Radio Amateurs Licence • Logic/Digital techniques
- Examination courses (City & Guilds etc.) in electronics
- Semi-conductor technology
- Training Kits (Signal Generators, Digital Meters etc.)

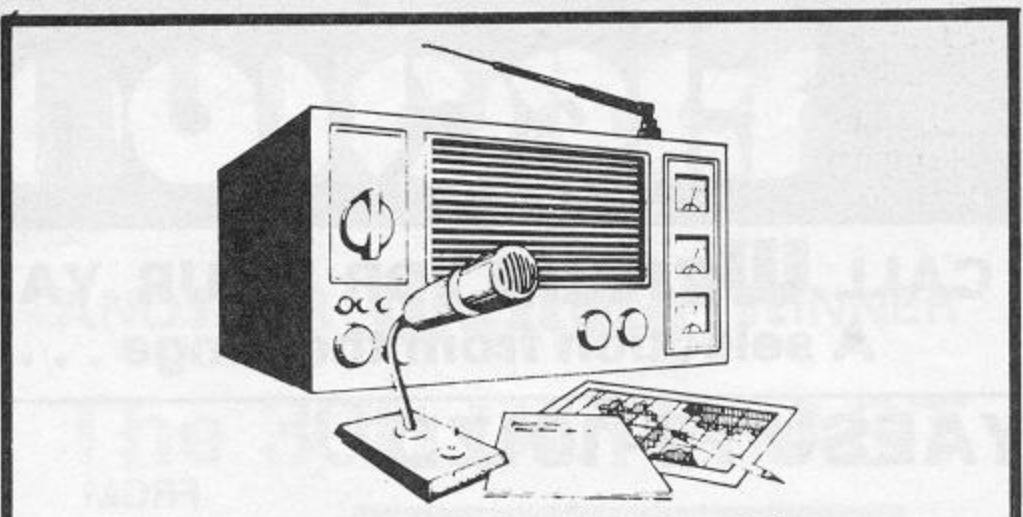

# BECOME A RADIO AMATEUR

Learn how to become a radio amateur in contact with the whole world. We give skilled preparation for the G.P.O. licence. No previous knowledge required.

Free! Brochure without obligation to :-  
**British National Radio & Electronic School**  
READING, BERKS. RG1 1BR

Name .....

Address .....

SWT/9/815/817R BLOCK CAPS PLEASE

Please send your FREE brochure without obligation to :-

Name .....

Address .....

BLOCK CAPS PLEASE

I am interested in :-

PRACTICAL ELECTRONICS .....

MICROPROCESSORS .....

OTHER SUBJECTS (please state your interest) .....

BRITISH NATIONAL RADIO & ELECTRONICS SCHOOL  
READING, BERKS. RG1 1BR SWT/9/815/817R

# NORTHERN COMMUNICATIONS

FDK AZDEN · CUSHCRAFT · YAESU · FDK · STANDARD · JAYBEAM  
LUNAR · ASP · SWAN-CUBIC · G-WHIP · MM · CDE SEM

## AND NOW FOR SOMETHING REALLY NEW!

2 metre or marine

- 12v DC
- 15x19x5cms mobile bracket + int. speaker



A VHF monitor receiver with VFO plus 12 optional scanning channels for **£46.00** inc. VAT. Carriage free.

Crystals for scanner **£2.25** each.

## 'POWER HOUSE' SPECIAL OFFER SWAN 100Mx +

A unique opportunity to obtain this 100watt CW/SSB Output 80-10 metre transceiver. Superb and simple operation, built in VOX, calibrator NB.RIT, Solid State P.A. at a one off price.



Normal price 100Mz **£422.00**  
Matching 20amp PSU **£135.00**

**SPECIAL OFFER:-**  
A complete FH Mobile station with - 100Mx, top quality Shure microphone + G Whip 3band mobile Antenna for **£389.00**  
OR:- Swan 100Mx + 20 amp supply **£499.00**

Also in stock the Swan Cubic Astro 150 & New 103



Box 2, 299-303 CLAREMOUNT ROAD, HALIFAX HX3 6AW, West Yorkshire  
VISIT OUR SHOWROOM - Tues. - Sat. inc. 9.45 a.m. - 5.30 p.m.  
Tel: (0422) 40792 and 24-hour answering service



## ROTATOR BARGAINS

In addition to being noted as a leading supplier of Antennas, masts and fixings we are able to supply more than 20 different styles of antenna Rotators, by leading manufacturers. From our extensive range we have selected just two, for special attention, this month.

**RO-250** The successor to the Stolle 2050, now available from Hirschmann. A 'through' style rotator, ideal for VHF beams or azi/elevation and polarisation applications. 25kg load with easy 3 core type cable control system. RO-250 complete with control box, inc VAT and delivery **£45.00.**



**SI-100** Optional alignment bearing for increased load bearing by 10kg., inc VAT and delivery **£12.00**

**NEW SU4000** by Skying, A medium/heavy duty 200kg load rotator, in Melamine coated, reinforced diecast alloy housing. Stationary braking torque 1500kg cm. 6 core control Designed to be Durable, Quiet and Weather Proof. Supplied complete with insulated, safe ABS plastic control unit with meter style display. A very nice unit! SU4000 complete with control box, inc vat and delivery **£85.00**

## WIDEBAND ANTENNA

The new "NORCONE DISC 512" is a wideband, unity gain antenna, specially developed for coverage of 66MHz to 512MHz. An ideal partner for the BEARCAT SX200N and other scanning monitor receivers. It may also be used for transmission. Full coverage of 70, 144, 432 MHz Amateur bands, Aircraft, Marine and Public Services. . . . (a) **£25.95**

## SPECIAL OFFER

SX200N SPECIAL OFFER. Latest model SX200N Scanning Receiver + Norcone 512 inc. Vat and delivery **£285.00**

## ZL-12 COMPACT YAGI

13db gain, compact 2 metre Yagi. 10'6" boom, lightweight rugged design. Hundreds of this award-winning antenna already in use. Send for details. **£28.75** p.p. £1.75

## ZL-8 SUPER COMPACT YAGI

9db gain, super compact 2 metre Yagi. 6'0" boom, lightweight rugged design. Ideal for limited spaces and portable operations. Send for details. **£17.95** p.p. £1.75



# P.M. ELECTRONIC SERVICES

PRICES SHOWN EXCLUDE VAT  
UK CUSTOMERS PLEASE ADD 15%

2 ALEXANDER DRIVE, HESWALL  
WIRRAL, MERSEYSIDE, L61 6XT

Tel: 051-342 4443. Cables: CRYSTAL, BIRKENHEAD.

## CRYSTALS MANUFACTURED TO ORDER

Prices shown are for one off, to our amateur specs., closer tolerances are available. Please send us details of your requirements.

**A Low frequency fundamentals in HC13/U or HC6/U**  
Adj. tol. ±50ppm. Temp. tol. ±100ppm 0 to 70°C.  
6.0 to 19.999kHz £28.12 100 to 159.99kHz £9.25  
20 to 39.999kHz £17.74 160 to 499.99kHz £6.19  
40 to 79.999kHz £12.40 500 to 799.99kHz £7.30  
80 to 99.999kHz £10.60

**B High frequency fundamentals/overtones**  
Adj. tol. ±20ppm. Temp. tol. ±30ppm 10 to 60°C.  
800 to 999.9kHz (fund) HC6/U £9.75  
\* 1.0 to 1.499MHz (fund) HC6/U £10.35  
\* 1.5 to 2.599MHz (fund) HC6/U £4.93  
\* 2.6 to 20.99MHz (fund) HC6/U £4.48  
\* 3.4 to 3.999MHz (fund) HC18 & 25/U £6.21  
\* 4.0 to 5.999MHz (fund) HC18 & 25/U £4.93  
\* 6.0 to 20.99MHz (fund) All holders £4.48  
\* 21 to 24.99MHz (fund) " £6.73  
\* 25 to 30MHz (fund) " £8.28  
\* 21 to 62.99MHz (30/T) " £4.48  
\* 60 to 105MHz (50/T) " £5.16  
\* 105 to 125MHz (50/T) HC18 & 25/U £7.76  
125 to 180MHz (O/T) " £7.50  
180 to 25MHz (O/T) " £12.49

\*Delivery Normally 5/6 weeks (express available), all other frequencies 7/8 weeks.

**Holders: Low frequencies** HC13/U or HC6/U dependent on frequency.

**Mid and High frequencies** are available in HC6/U, HC18/U or HC25/U unless otherwise shown.

HC17/U (replacement for FT243) and HC33/U (wire end HC6/U) available as per HC6/U above at 30p extra on HC6/U price

Unless otherwise specified, fundamentals will be supplied to 30pf circuit conditions and overtones to series resonance.

### CRYSTALS FOR PROFESSIONAL USE

We can supply crystals to most commercial and MIL specifications, with an express service for that urgent order. Also for commercial use, eg TV or computer crystals, etc, we can supply at very competitive prices. Please send S.A.E. for details or telephone between 4.30-7pm and ask for Mr. Norcliffe.

### EXPRESS SERVICE

Many types of made to order crystals are available on our "EXPRESS SERVICE" - with delivery of three days on our class "A" service. Telephone for details.

TERMS: CASH WITH ORDER - MAIL ORDER ONLY - S.A.E. WITH ALL ENQUIRES - PRICES INCLUDE P. & P. (BRITISH ISLES) EXCEPT WHERE STATED - OVERSEAS CHARGED AT COST.

## TWO METRE CRYSTALS

CRYSTAL FREQUENCY RANGE USE (TX or and HOLDER)	4MHz-TX-HC6/U	6MHz-TX-HC25/U	8MHz-TX-HC6/U	10MHz-RX-HC6/U	11MHz-RX-HC6/U	12MHz-TX-HC25/U	14MHz-RX-HC25/U	18MHz-TX-HC25/U	44MHz-RX-HC6/U	44MHz-RX-HC25/U	52MHz-RX-HC25/U
144.4 (433.2)	b	e	b	e	e	b	e	e	e	e	e
144.480	e	e	e	e	e	e	e	e	e	e	e
144.800	c	e	e	e	e	c	c	c	c	c	e
144.850	e	e	e	e	e	e	e	e	e	e	e
145.000/ROT	a	c	a	c	c	b	b	b	a	a	c
145.025/R1T	a	c	a	e	e	b	e	b	e	e	e
145.055/R2T	a	c	a	e	e	b	e	b	e	e	e
145.075/R3T	a	c	a	e	e	b	e	b	e	e	e
145.100/R4T	a	c	a	e	e	b	e	b	e	e	e
145.125/R5T	a	c	a	e	e	b	e	b	e	e	e
145.150/R6T	a	c	a	e	e	b	e	b	e	e	e
145.175/R7T	a	c	a	e	e	b	e	b	e	e	e
145.200/R8T	a	c	a	e	e	b	b	b	a	a	c
145.300/S12	e	e	e	e	e	e	e	e	e	e	e
145.350/S14	e	e	e	e	e	e	e	e	e	e	e
145.400/S16	e	e	e	e	e	e	e	e	e	e	e
145.425/S17	e	e	e	e	e	e	e	e	e	e	e
145.450/S18	a	e	a	e	e	b	b	b	a	a	e
145.475/S19	a	e	a	e	e	b	b	b	a	a	e
145.500/S20	a	c	a	c	c	b	b	b	a	a	c
145.525/S21	a	c	a	c	c	b	b	b	a	a	c
145.550/S22	a	c	a	c	c	b	b	b	a	a	c
145.575/S23	a	c	a	c	c	b	b	b	a	a	c
145.600/R0R	a	c	a	c	c	b	b	b	a	a	c
145.625/R1R	e	e	e	e	e	b	e	a	a	a	c
145.650/R2R	e	e	e	c	e	b	e	a	a	a	c
145.675/R3R	e	e	e	c	c	e	b	e	a	a	c
145.700/R4R	e	e	e	c	c	e	b	e	a	a	c
145.725/R5R	e	e	e	c	c	e	b	e	a	a	c
145.750/R6R	e	e	e	c	c	e	b	e	a	a	c
145.775/R7R	e	e	e	c	c	e	b	e	a	a	c
145.800/R8R	a	c	a	c	c	b	b	b	a	a	c
145.950/S38	a	e	e	c	e	e	e	e	a	e	e

PRICES: (a) £1.95, (b) £2.32, (c) £2.50, and (e) £4.48.

AVAILABILITY: (a), (b), (c) stock items, normally available by return (we have over 5000 items in stock). (e) 4/6 weeks normally but it is quite possible we could be able to supply from stock.

N.B. Frequencies as listed above but in alternative holders and/or non stock loadings are available as per code (e).

ORDERING. When ordering please quote (1) Channel, (2) Crystal frequency, (3) Holder, (4) Circuit conditions (load in pf). If you cannot give these, please give make and model of equipment and channel or output frequency required and we will advise if we have details.

**SEE YOU AT THE  
ARRA EXHIBITION  
at Castle Donnington 29th, 30th,  
31st October**

## 70 cm CRYSTALS

Due to the much higher multiplication involved (3 times that on 2m) all our stock 70cm crystals are to much higher tolerances than our standard range.

We are stocking the following channels: RBO (434.60/433.00), RB2 (434.65/433.05), RB4 (434.70/433.10), RB6 (434.75/433.15), SU8 (433.20), RB10 (434.85/433.25), RB11 (434.875/433.275), RB13 (434.925/433.325), RB14 (434.95/433.35), SU18 (433.45), SU20 (433.50) - TX & RX for use with: - PYE UHF Westminster (W15U), UHF Cambridge (U10B), Pocketfone (PF1) AND UHF PF70 Range, and STORNO CQL/CQM 662 all at £2.32. For the U450L Base Stn we have the TX crystals for the above channels. The RX crystals for the U450L Base Stn together with TX and RX crystals for any other 70cm channel (eg RB/SU12 (434.90/433.30) RTTY, SU16 (433.40), SU22 (433.55) etc.) for most UHF equipments are available at £4.48 for crystals up to 63MHz, and £5.16 for 63 to 105MHz to amateur spec or £5.26 for up to 63MHz and £6.05 for 63 to 105MHz to the same closer spec as our stock items. Delivery approx. 5/6 weeks.

4m CRYSTALS FOR 70.26MHz - HC6/U  
TX8.7825MHz and RX6.7466MHz or 29.7800MHz £2.32

10.245MHz "ALTERNATIVE" I.F. CRYSTALS - £2.32  
For use in Pye and other equipment with 10.7MHz and 455kHz I.F.s to get rid of the "birdy" just above 145.0MHz. In HC6/U, HC18/U and HC25/U.

CRYSTAL SOCKETS - HC6/U, HC13/U and HC25/U (Low loss) 16p each. 10p P. & P. per order (P. & P. free if ordered with crystals).

CONVERTER/TRANSVERTER CRYSTALS - HC18/U  
All at £3.30, 38.6666MHz (144/28), 42MHz (70/28), 58MHz (144/28), 70MHz (144/4), 71MHz (144/2), 96MHz (1,296/432/144), 101MHz (432/28), 101.50MHz (434/28), 105.6666MHz (1,296/28) and 116MHz (144/28).

TEST EQUIPMENT FREQUENCY STANDARD CRYSTALS  
200kHz and 455MHz in HC6/U £3.50  
100kHz in HC13/U and 1MHz in HC6/U £2.95  
5MHz in HC6/U and 10MHz and 10.7MHz in HC6/U and HC25/U £2.80.

## CRYSTALS FOR MICROPROCESSORS

Please let us know your requirements e.g. 4MHz HC18/U. 1 off, £2.00; 100 off, £1.10; 1000 off, 99p; 25,000 off, 50p.

## ANZAC MD-108 DOUBLE BALANCED MIXER

5 500MHz supplied with full details for only £6.95.

## ANTENNA FAULT?

LOSING DX? Poor reports? Check it FAST with an Antenna Noise Bridge, MEASURE resonance 1-150MHz and radiation resistance 2-1000ohms, accurate ANSWERS directly, MORE DX, £15.70.

RARE DX UNDER QRM? DIG it OUT with a Tunable Audio Notch Filter, between your receiver and speaker, BOOST your DX/QRM ratio, 40dB notch, bypassed when off, HEAR the WEAK DX, £13.80.

TIME WRONG? MSF CLOCK is ALWAYS CORRECT - never gains or loses, SELF SETTING at switch-on, 8 digits show Date, Hours, Minutes and Seconds, larger digit Hours and Minutes for easy QUICK-GLANCE time, receives Rugby 60KHz atomic time signals, built-in antenna, 1000Km range, get the TIME RIGHT, £62.80

Each fun-to-build kit includes all parts, printed circuit, case, postage etc, instructions, money back assurance so GET yours NOW.

## CAMBRIDGE KITS

45 (SW) Old School Lane, Milton, Cambridge.

## TMP ELECTRONIC SUPPLIES

Stockists of Yaesu, Jaybeam, Hy-Gain, Swan, Amidon Cores, KDK, FDK, Microwave Modules, RSGB Books, ASP, Leader, Cushcraft, Daiwa, Dentron, Hansen.

FRG-7700 ..... £309.00 FRG-7 ..... £199.00  
R1000 ..... £285.00 SRX-30 Digital ..... £195.00  
FRG-7 Digital ..... £230.00 SR-9 2 Metre ..... £46.00  
Copper Aerial Wire 140' ..... £8.90 Balun Kits 3.5-21MHz ..... £6.00  
70' ..... £5.40 14-30MHz ..... £7.20

### AIRBAND RECEIVERS

Digital Flight Scan ..... £215.00 SX200N 26-512MHz ..... 264.00  
R512 8 Channel Scanner ..... £138.00 R517 Sky Ace Handheld ..... £49.00  
Sharp FX213AU MW/Air Band ..... £14 Academy MW/FM/Air Band ..... £13.75  
Converter 118-124MHz IF 18-24. £25.00 VHF Air Band Guide Book ..... £2.00

Usual stocks of coax, plugs, etc. SAE with all enquiries.

BRITANNIA STORES, LEESWOOD, Nr. MOLD, CLWYD CH7 4RU  
Tel: Pontybodkin 846 (035 287)

Open Mon., Wed., Thurs., Fri. 9.30-5p.m. Sat. 9.30-1p.m. Lunch 1-2p.m. Closed Tuesday.

# ENTER THE NEW WORLD of KW+TEN-TEC

## Introducing a New Concept in HF communications

A NEW SERIES WITH NEW FEATURES, NEW PERFORMANCE, AND ALL 9 HF BANDS.



### KW + TEN — TEC OMNI-C\*

- with comprehensive facilities • superb SSB with 8 pole filter • all 6 present HF bands (+ all 3 new bands 10.18 + 24.5 MHz) covering 10-160 meters
- 2 speed CW break — in facility • new "hang" AGC for smoother operation
- 200 watts max input power.

Come to KW for all your other amateur radio requirements KW service and guarantee — KW maintains the tradition of service the company is renowned for. Output-transistors unconditionally guaranteed for 12 months. The KW — TEN — TEC units offered above are introduced as a prelude to fully UK assembled equipment.

### KW + TEN — TEC DELTA\*

- HF transceiver 10 — 160 meters, 9 bands including new bands
- 200 watts max input power
- compact yet easily serviceable
- superb mobile transceiver, nominal 13v D.C. input.

### KW + TEN — TEC ARGONAUT\*

- the best in QRP is now better than ever
- total solid state full band coverage 10-80 meters
- 5 watts input • imported receiver sensitivity
- full CW break-in
- WWV receive at 10 and 15 MHz.

(\*A full range of accessories is available for KW+TEN-TEC equipment)

other KW units available.  
KW 107 Supermatch KW trap dipole  
KW E-Z match KW traps  
KW Balun KW antenna switch

## KW COMMUNICATIONS LTD

Vanguard Works, Jenkins Dale, Chatham ME4 5RT  
Tel: 0634-815173 Telex: 965834 KW COMM G

# Lee Electronics Ltd



London's Leading Stockists of:  
STANDARD YAESU ICOM FDK KDK MICROWAVE MODULES LUNAR SST SHURE HI-MOUND CDE STOLLE  
TELECOMM ANTENNAE J-BEAM SWAN KATSUMI, ETC.



## YAESU GENERAL COVERAGE COMMUNICATIONS RECEIVER FRG7700



- ★ 150KHz - 29.999MHz, FULL COVERAGE HIGH STABILITY DUAL PLL SYSTEM
- ★ AUTOMATIC BAND PASS FILTER SELECTION
- ★ 3 FILTERS FOR AM RECEPTION
- ★ FAST/SLOW AGC SWITCH
- ★ NARROW BAND FM RECEPTION CAPABILITY
- ★ TIMER FACILITIES

- ★ SINPO CODED SIGNAL STRENGTH METER
- ★ RECEIVER NOISE BLANKER
- ★ TWO ATTENUATOR FACILITY
- ★ HIGH QUALITY AUDIO (1.5 WATTS OUTPUT)
- ★ 24 VOLT AC OR (WITH ADAPTOR KIT) 13.8 VOLTS DC
- ★ RECEIVES SSB, AM, CW AND FM (NARROW BAND)

PRICE £309.00 inc VAT

£389.00 inc VAT WITH 12 CHANNEL MEMORY

Free amplifier worth £15.00 with every receiver purchased

400 EDGWARE ROAD  
LONDON W2  
01-723 5521 Tlx: 298765



INSTANT H.P.  
& P/PEX. WELCOME

Send 25p for  
full details  
of our range.





**THE LATEST SOMMERKAMP — FRG 7700 COMMUNICATION RECEIVER.** 150kHz - 30MHz multimode, digital frequency readout, 12 programmable memories, variable bandwidth, built-in clock/timer. Price £389.00. **FT207 SYNTHESIZED 2 METRE TRANSCEIVER.** 144-148MHz in 12½kHz steps, 4 memories. Inc. case and nicad charger special at £159.00 inc. VAT.

**BEARCAT 220FB RECEIVER £239.00.**  
**SPECIALS: 2 METRE TS280 50 Watt MOBILE TRANSCEIVER.** Fully Synt. at only £159.00 inc. VAT. Special. **TS280 10 Watt version £129.00 inc. VAT. Special.**

**FT480R MULTIMODE MOBILE BASE £349.00 inc. VAT.**  
**NEW — FT780R 70cms MULTIMODE £399.00 inc. VAT.**  
**NEW NEW — BRAND NEW FROM SOMMERKAMP** the all-mode 2m portable FT-290. So many features ● 10 memories ● Memory scan ● 2 VFOs ● Band scan ● Clarifier ● FM/LSB/USB/CW ● LCD readout ● Real S-meter ● Priority channel ● 2.5W out.  
 Our price £229.00 inc. VAT.

**NEW — H.F. FT277ZD Mk III**  
**SOMMERKAMP H.F. RIGS.** FT277D (= FT101 with extras) AM version £649.00, FM version £679.00. FT307 (= FT107 with extras) Price on application. FT767 (= FT707 with extras) £579.

**PART EXCHANGE your old gear and get a good deal.**

**ROTATORS, ANTENNAS, GENUINE SOMMERKAMP SWR BRIDGES AND 12 VOLT POWER SUPPLIES.**

All prices include VAT. Barclaycard and Access welcome.  
 H.P. terms available. Prices may change without notice. S.A.E. for details.



**GEMINI**  
 COMMUNICATIONS

**YOUR SOMMERKAMP  
 IMPORTER.**

1, Railway Road, Blackburn, Lancs. Telephone: 51842.  
 (Telephone Evenings: Bolton 592929 G4GHE).

## (“SITUATIONS” AND “TRADE”)

20p per word, minimum charge £2.40. No series discount. All charges payable with order. Insertions of radio interest only accepted. Add 50 per cent for Bold Face (Heavy Type). No responsibility accepted for transcription errors. Box numbers 40p extra. Send copy, with remittance, to the Classified Dept., Short Wave Magazine Ltd., 34 High Street, Welwyn, Herts. AL6 9EQ.

### TRADE

**Trap dipoles, custom built, anti-TVI models, Tx-ing, SWL-ing, 24-ft. to 108-ft.** Send s.a.e. for lists. — **G2DYM, Uplowman, Tiverton, Devon. (Tel: 03986-215).**

**Automatic Morse decoder, low cost easy-build 9v. circuit, accepts audio input or practice key, gives continuous readout on 12-character alphanumeric display.** Send £3.95, plus large s.a.e. for fully detailed 17-page construction manual. Parts and PCB available. — **N. MacRitchie (Micros), 100 Drakies Avenue, Inverness IV2 3SD. (Tel: 0463-221194).**

**Unforgettable Caribbean winter holidays** aboard luxury skippered sloop “Moody Mistress” based English Harbour, Antigua. Operate /MM with latest Icom IC-720A and standby Atlas 215X rigs, while your YL/XYL gets the suntan she missed this summer! Charter agents: **Montague Marine Management, 43a North Hill, Plymouth. (Tel: 0752-665187).**

**VHF converter, 50-300 MHz (varicap), 28-30 MHz tunable IF, very high sensitivity, £9 inc. p/p.** Send s.a.e. for data and lists. — **H. Cocks, Cripps Corner, Robertsbridge, Sussex. (Tel: 058083-317).**

**“Worked 95 QTH squares on 432 MHz?”** 432 MHz PA's, two 4CX250B's, 1 kW (3 types). Tested, complete, £250; pre-built kit, £100; metalwork pre-built, £70. Ex-stock. Coming soon: 144 MHz 1.5 kW amp., single tube. — **GJ4ICD, QTHR. (Tel: 0534-26788).**

**PCB's, or built and tested boards for G4FRX power supply and control unit.** — **G4JZQ, 21 Oxford Road, London N.4. (Tel: 01-272 4135 after 6 p.m.).**

**October issue: due to appear September 25th. Single copies at 75p post paid will be sent by first-class mail for orders received by Wednesday, September 23rd, as available.** — **Circulation Dept., Short Wave Magazine Ltd., 34 High Street, Welwyn, Herts. AL6 9EQ.**

**For Sommerkamp in Stockport.** We also stock Belcom, Daiwa, Trio (receivers), M.M., scanners, airband monitors, aerials and accessories. — **Fairbotham & Co. Ltd., 58-62 Lower Hillgate, Stockport, Cheshire. (Tel: 061-480 4872).**

**Towers, 35-ft. telescopic, beautifully built, strong, light, £210.** 2m. omnidirectional ¾-wave, 4.5dB gain, £21. — **AAC, 132 Hermon Hill, London E18. (Tel: 01-530 6118).**

**1920's onward valves, wireless's.** Lists 25p, s.a.e. please. — **Sole Electronics, 37 Stanley Street, Ormskirk, Lancs. L39 2DH.**

**QSL cards.** Sample pack and price list forwarded on receipt of 20p stamp. — **Derwent Press, 69 Langstone Drive, Exmouth, Devon EX8 4HZ.**

**Good second-hand equipment always wanted.** Come to **AMATEUR RADIO EXCHANGE** for the best deal. — **2 Northfield Road, Ealing, London W13 9SY. (Tel: 01-579 5311.)**

**TVI/AFI? Cure it with ferrite rings, 67p each including postage.** — **TMP Electronics, Britannia Stores, Leeswood, Mold, Clwyd CH7 4RU.**

**Aerial wire, 14 s.w.g. hard-drawn copper: 70 ft. coils £5.50; 140 ft. coils, £8.90.** Including postage. — **TMP Electronics, Britannia Stores, Leeswood, Mold, Clwyd CH7 4RU.**

# The World's Radio Broadcasting Stations and European FM/TV

## C R Both

The World's Radio Broadcasting Stations provides the radio enthusiast with information on stations likely to be heard during worldwide listening.

European long, medium and FM stations and the world's short wave stations are listed in groups by country in order of frequency. Wavelength, power, map coordinates and the name of the town are given.

European VHF and UHF TV stations are also listed by country and accompanied by details of their power, signal polarisations, programme information, town location and map coordinates.

213 x 143 mm      226 pages  
 0 408 01156 4      £5.50      Paperback

**ORDER NOW from your local bookseller**

In case of difficulty send cash with order to Patricia Davies, Marketing Manager at the address below.

**Newnes Technical Books** a division of Butterworths  
 Borough Green, Sevenoaks, Kent TN15 8PH

(SWM 9/81)

**Radio Amateur Examination City and Guilds.** Pass this important Examination and obtain your G8 Licence with an RRC Home-Study Course. For details of this and other courses (GCE, professional examinations, etc.) write or phone: **THE RAPID RESULTS COLLEGE, Dept. JV1, Tuition House, London SW19 4DS.** Careers Advisory Service, 01-947 7272 or ring 01-946 1102 for Prospectus (24-hr. Recordacall).

**QSL's, 5000 for £38, c.w.o.** Send s.a.e. for samples. — Printshop, 89 Derwent Street, Consett DH8 8LT.

### READER'S ADVERTISEMENTS

10p per word, minimum charge £1.50 payable with order. Add 25p per cent for Bold Face (Heavy Type). Please write clearly, using full punctuation and recognised abbreviations. No responsibility accepted for transcription errors. Box Numbers 40p extra. Send copy, with remittance, to the Classified Dept., Short Wave Magazine Ltd., High Street, Welwyn, Herts. AL6 9EQ.

### READERS

**Selling:** Yaesu FRG-7, excellent condition, with fine tune and manual, £120. Buyer collects. — Ring Bristol 645885.

**Wanted: Most urgently, for small research project: QSL's (amateur and commercial), envelopes, etc., used postally pre- and post-war from Iceland, Greenland, Faroes, Jan Mayen, Spitzbergen, Bear Is. and Scandinavia. — Box No. 5752, Short Wave Magazine, 34 High Street, Welwyn, Herts. AL6 9EQ.**

**Wanted:** HRO S-meter and coil packs, any condition. Also small ex-govt. Tx/Rx, 2-8 MHz approx., AM or CW. — Ring Wooster, Medway 253056.

**Selling:** SRX-30 communications receiver, mint condition, with 30-ft. Telomast (dismantled), £135. — Ring Phillips, Wantage (02357) 2473.

**For Sale:** "G2DAF" Mk. II Tx and Rx, mechanical filter versions, operational all bands, full drive on 10m., built by advertiser (well finished in cabinets, photographs available), recently overhauled, re-valued (6146B's), with quality dynamic mic. and spare valves, £100. — Ring Hoban, G3EGC, 0204-51502.

**Wanted:** Hammarlund SP-600JX receiver, prefer good condition with no modifications whatsoever. I will send a box for transit by B.R.S. Please send details of condition and price (stamp refunded). — Barker, 42 Swinhoe Gardens, Wideopen, Newcastle-upon-Tyne NE13 6AF.

**Sale:** Yaesu FR-101S digital receiver, with manual, little used, immaculate, £400. — Ring Lawton, Stourbridge 72037 evenings.

**Selling:** Sony CRF-220 World Zone multiband receiver, good condition, £200. — Ring Canterbury 58293 after 6 p.m.

**Sale:** Kenwood TS-820 HF transceiver, good performer, as new, £475. Eddystone 770R, 19-165 MHz, good condition, £120; 680X, 550 kHz to 30 MHz, £85. MM144/28LO converter, new, £20. Pye Compact, 70cm., £25. — Perrin, G4AFY, QTHR. (Tel: Kidderminster 63358 or 753358).

**Wanted:** Information on R. 107 wartime Rx, 1.2 to 17.5 MHz. — Salkeld, 814 Manchester Road, Rochdale (32759), Lancs.

**Selling:** HW-100 Tx/Rx with PSU and speaker, mic., immaculate 80/10m. station, £200. AR88 Rx, good, £75. Buyers collect. — Ring Platt, G3RPU, 061-430 3127.

**For Sale:** Bearcat 220FB 20-channel scanning receiver, £195. — Ring Lawton, Stourbridge 72037 evenings.

**Sale:** Daiwa DR-7500 rotator; DC-7001 controller, will take 3-ele beam, as new, £70. — Ring Williams, 0376-23604.

# Three pieces of good news for a change.

Heathkit announce three brand new kits. Precision made for you to build. Easily. Faultlessly. With superb results you'll be proud of.

### SA 5010 u Matic (TM) Memory Keyer

Uses a microprocessor providing buffer storage up to 240 characters. Speed, weight, spacing and auto repeat selected by 'command strings'. Speeds 1-99 words a minute.

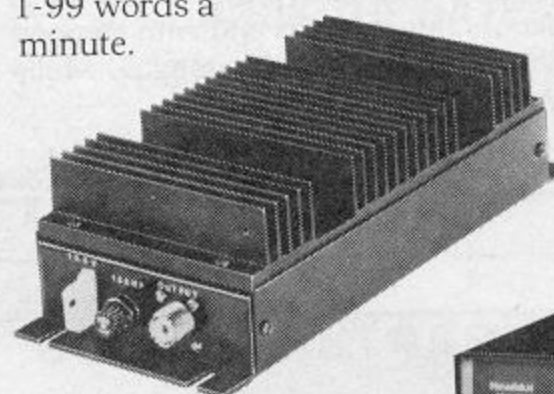
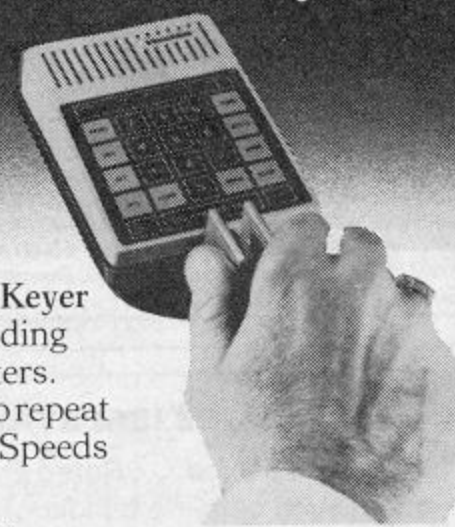

### SA 2060 Deluxe Antenna Tuner

Covers 160 to 10 meters with continuous tuning. Built-in dual wattmeter/SWR bridge. Handles up to 2Kw PEP on SSB. Matches any antenna to any rig at any frequency within the range.

### VL 1180 144-146 MHz Linear Amplifier

80 watts output at 10 watts drive for use on FM and SSB.



There are many other high quality amateur radio kits to choose from. All exceptionally good value for money.

Read all about them in the new Heathkit catalogue. It's news you'll find well worth broadcasting. Send for your copy now.



To: Heath Electronics (UK) Limited, Dept ( SW9 ), Bristol Road, Gloucester GL2 6EE.

Please send me a copy of your new catalogue. I enclose 28p in stamps.

Name \_\_\_\_\_

Address \_\_\_\_\_

NB. If you are already on the Heathkit mailing list you will automatically receive a copy of the latest Heathkit catalogue without having to use this coupon.



You build on our experience

# HEATHKIT

HEATH  
ZENITH

## EASIBINDERS

To hold together 12 copies of the new-size "Short Wave Magazine" are now available.

Strongly made with stiff covers, and bound in red Wintrel Achina, the binders have the title and date frame blocked in gold on the spine. Price £4.65 including post/packing.

Publications Dept.

### Short Wave Magazine Ltd.,

34 High Street, Welwyn, Herts. AL6 9EQ.

## MORSE MADE EASY BY THE RHYTHM METHOD!

FACT NOT FICTION •

No expensive equipment required only a turntable

If you start RIGHT you will be reading amateur and commercial Morse within a month. (Most students take about three weeks). That's why after 25 YEARS we still use three scientifically prepared special records with which you cannot fail to learn the MORSE RHYTHM automatically. It's as easy as learning a tune. 18w.p.m. in 4 weeks guaranteed. Complete course comprising 2x 12" + 1 x 7" multi-speed records + books. £5.50 plus (U.K. p.p. + 75p. Overseas, sufficient for 750 grms.). Despatch by return from: — S. Bennett, G3HSC, (Box 14), 45 Green Lane, Purley, Surrey CR2 3PQ. 01-660 2896.

### MAINS ISOLATION TRANSFORMERS

Ex Rank-Toshiba. . . . Rated at, at least, 250 watt and housed in cases with carrying handle. . . . Input Mains and with stepped isolated outputs from 220 to 300 volts in 7v steps . . . fully fused. . . . Bargain buy at £6.50 each. Post £2.40p.

W. H. WESTLAKE, CLAWTON, HOLSWORTHY, DEVON.

### ANTI-TVI TRAP DIPOLES

Indoor models . . . . . £14.50 & £27.50  
Outdoor models . . . . . £30.00 & £36.00  
Tx-ing models . . . . . £52.50 & £59.75

Lists 10 x 8in 20p SAE. Aerial Guide 50p.

Publication "Indoor and Invisible Aerials for S.W.L.s" — £3.50  
Callers Welcome. Tel: 03986-215

G2DYM, UPLOWMAN, TIVERTON, DEVON

### MORSE CODE RECEIVING AND SENDING

**Receiving:** C-90 Cassettes. CASSETTE A for Amateur Radio examination preparation. Speed slowly increasing from 1-12w.p.m. CASSETTE B for professional examination preparation; computer produced morse from 12-25w.p.m. incl. international procedure signs and symbols and their incorporation into messages.

**Sending:** Morse Key and Buzzer Unit for sending practice and own tape preparation. Phone output. Prices: each cassette, incl. booklets, £4.75. Morse key and buzzer unit, £4.75.

Prices incl. postage, etc. Non-Europe Airmail £1.50 extra

MH ELECTRONICS (Dept. 3), 12 Longshore Way, Milton, Portsmouth PO4 8LS

## ALL VALVES & TRANSISTORS

Call or phone for a most courteous quotation  
01-749 3934

We are one of the largest stockists of valves etc. in the U.K.

COLOMOR ELECTRONICS LTD. 170 GOLDHAWK ROAD LONDON W12-

### G2BAR HAM BAND AERIALS

UHF 6 element YAGI 432MHz	VAT inc.	£8.05	£1.15P.P.
11 element YAGI 432 MHz	"	£11.50	"
VHF 5 element 2 metre YAGI	"	£8.50	"
VHF 8 element 2 metre YAGI	"	£11.05	"

For further information of Dipoles and HF GAMMA MATCH BEAMS — Please send 30p stamps.

UPPINGTON TELE-RADIO (BRISTOL) LTD.

12-14 Pennywell Road, Bristol BS50TJ.

Telephone 0272 557732

**Selling:** TS-520S with CW filter, as new condition, boxed, £350. SB-200, mint condition, £250. Carriage extra on both items. — Ring Jones, G3RCU (not QTHR), Christchurch 484211 day, 475048 evenings.

**For Sale:** DX-302 receiver, digital display, as new, boxed, under manufacturer's guarantee, £160 or near offer. — Ring Hanghey, 0908-642398.

**Selling:** Trio R-820, very good condition, to be seen and collected, £450. — Ring Sheffield 588671.

**Sale:** Trio 7500 2-metre transceiver with PS-6 power supply, with manual, boxed, as new, £200. — Ring Salt, G4ITL, 0279-20478 evenings.

**October issue: due to appear September 25th. Single copies at 75p post paid will be sent by first-class mail for orders received by Wednesday, September 23rd, as available. — Circulation Dept., Short Wave Magazine, 34 High Street, Welwyn, Herts. AL6 9EQ.**

**For Sale:** Hy-Gain 18-AVT/WB, 80-10m., £35. — Ring Eklund, 01-908 0070 (Wembley).

**Selling:** Trio TR-7200G Tx/Rx, 2m. FM, 13 channels, not used mobile, unmarked, perfect, £100. Microwave Modules 2-metre transverter, as new, £65. Buyers collect please, or carriage extra. — Ring Dolan, G3KZU, Oxford (0865) 63000 evenings.

**Exchange:** Sharp MZ80K computer, 36K memory, 9 months old, 100-plus programs, for FT-707. Or would consider TS-120/130 with linear. — Avery, G8MGA, QTHR.

**For Sale:** Tangerine Microtan 65 computer, latest 'Tanbug', with graphics, keyboard and MPS-1±12v. power supply (RTTY program available from G8WPU), as new, £100. — Watson, G3WMQ, QTHR. (Tel: 01-903 4363).

**Sale:** Yaesu FT-902DM and FC-902 ATU, 6 weeks old, never used, £750. — Ring Derby 557705 anytime.

**Selling:** Eddystone receivers: 880/2, thirty 1 MHz bands, £200; 770R, VHF, £95. Both 'or near offer'. Or W-H-Y? — Ring Moscrop, G4EMG, 01-534 3460 evenings.

**Sale:** SR-9 2m. Rx, works well but no on/off switch. First sensible offer accepted. — Readman, 88 Aberford Road, Oulton, Leeds LS26 8HP.

**For Sale:** I have lost my childhood interest in short wave listening, hence selling my FRG-7700 receiver which was purchased only in April. Offers around £250. — Worrell, 19 Teal Road, Newport Brough, N. Humberside HU15 2PW.

**Selling:** Lowe SRX-30D general coverage receiver, mint and boxed, three months old, £125 or near offer. Joystick Supermatch aerial and ATU, £30 or near offer. — Ring Kerry, Chester 677238.

**Wanted:** Aerial tuning unit for SWL use. Details and price, please. — Bartlett, 66 Gainsborough Road, Stowmarket, Suffolk IP14 1LJ.

**Sale:** FT-101Z, immaculate, £385. Transmitter, 2m. FM, 100W, £50. Cordless telephone, as new, £75. 12AVQ, £15. — Ring Dunstable (0592) 601401.

**For sale:** FRG-7 with YH-55 headphones, little used, £160. — Ring Hall, Shrewsbury (0743) 53034.

**Selling:** Brand new, unused, Samson ETM-3CS electronic keyer, suitable all types of rigs, £70 or near offer. Heathkit HD-1410 electronic keyer, mint condition, £25. — Ring Curran, Harlow 36835.

**Sale:** Yaesu Musen FRG-7, recently checked by S.M.C. Ltd., excellent performance, SSB and AM filters, £135. — Ring Doel, New Milton 612823.

**For Sale:** Icom VHF marine, latest from Icom, as new, never used, £185. — Mansi, G8VVK, QTHR.

## AMATEUR RADIO RETAILERS ASSOCIATION

Secretary: Fred Hopewell, P.O. Box 36, Loughborough LE11 1DW  
TENTH ANNIVERSARY

## AMATEUR RADIO AND ELECTRONICS

## ★ EXHIBITION ★

DONINGTON PARK  
CASTLE DONINGTON  
29/30/31 OCTOBER



NOTE THE  
NEW VENUE!

OPEN DAILY, 10 a.m. to 6 p.m.

DON'T MISS THIS EXCITING EVENT — BARGAINS GALORE,  
REFRESHMENTS, BAR AND ALL THE USUAL AMENITIES

£500 IN VOUCHER PRIZES TO BE WON!

PLUS FABULOUS FREE DRAW PRIZES THROUGHOUT THE EXHIBITION!

ADMISSION: £1. Concessionary Tickets 80p for Parties of 15 or over

Advance Tickets may be obtained direct from: Stuart Parker, Esq., Donington Park Racing Ltd., CASTLE DONINGTON, Derbys. DE7 5RP. Please enclose postage: up to 18 Tickets, 14p. 19-30 Tickets 20p. 31-50 Tickets, 26p.



BOOK THE DATES NOW  
FOR THE SHOW OF THE YEAR!

## S.E.M. P.O. BOX 6, CASTLETOWN, ISLE OF MAN

Tel: MAROWN (0624) 851277

### S.E.M. ACTIVE MULTIFILTER

Will improve ANY receiver on ANY mode. Gives "passband tuning" & "variable selectivity". Switched Hi-pass, Lo-pass, peak or notch. Selectivity 2.5KHz - 20Hz tunable from 2.5KHz - 250Hz. PLUS another notch which can be used in any switch position and covers 100Hz - 10KHz. TRY ONE ON 14 DAYS APPROVAL. £57.00 Ex stock.

### S.E.M. EZITUNE

"In my fifty years on the air, this is the most useful gadget I've ever seen" Connects in aerial lead, produces S9 + (1-170MHz) noise in receiver. Adjust A.T.U. for minimum noise. You have now put an exact 50 Ohms load into your transceiver. Fully protected, you can transmit through it, to save your P.A. & stop QRM. £25.00\* Ex stock.

### S.E.M. TRANZMATCH

The most VERSATILE transmatching system. Will match from 15 to 5000 Ohms BALANCED or UNBALANCED at up to 1kW. Link coupled balun means no connection to the equipment which can cure TVI both ways. SO239 and 4mm connections for co-ax or wire feed. 160-10 metres TRAN Z MATCH £65.00 80-10 metres £58.00. EZITUNE built-in (see above) £19.50 extra. NOW IN STOCK AGAIN.

### THE SENTINEL AUTO Mk II 2 or 4 METRE PRE-AMPLIFIER

These include NEW PROTECTION circuit to give MAXIMUM LEGAL through power rating. Completely new third generation DUAL GATE MOSFET pre-amp giving 1dB N.F. and 20dB gain with GAIN CONTROL and OFF switch (straight through when OFF) The High Q tuned circuits for high selectivity. Size: 1½" x 2¼" x 4" £25.00\* Ex stock.

### SENTINEL STANDARD Mk II 2 or 4 METRE PRE-AMPLIFIER

Same as the AUTO less R.F. switch 12V 5mA. £15.00\* Ex stock.

### PA3

ONE cubic inch miniature 2 metre pre-amplifier. Same circuit as above. External gain can be added. Full instructions. £7.95 Ex stock.

70cms versions £4.00 extra. Marine Band Ex stock. Other frequencies to order.

### SENTINEL 2 METRE LINEAR POWER AMPLIFIER/PRE-AMPLIFIER

These units use the latest techniques and transistors for highest reliability and performance. Infinite SWR PROTECTED devices. ULTRA LINEAR, all modes. R.F. switched. Same POWER GAIN at lower drive powers. Supply 13.8V nominal. SO239S. Three models.

#### 1. SENTINEL 35

Twelve times Power gain. 3W IN 36W OUT. 4 amps. Max. drive 5W. 6" x 2¼" front panel, 4½" deep. £57.50 Ex stock.

#### 2. SENTINEL 50

Five times power gain. 10W IN 50W OUT. Max. drive 16W. Same size as the Sentinel 35. £69.50 Ex stock.



### 3. SENTINEL 100

Ten times power gain. 10W IN 100W OUT. Max. drive 16W. Size: 6½" x 4" front panel, 3½" deep. 12 amps. Price: £126.50 Ex stock.

All available less pre-amp for £8.00 less.

### SENTINEL H.F. WIDEBAND PRE-AMPLIFIER

2-40MHz. 15dB gain. Ideal for 15 and 10 metres and OSCAR or an ACTIVE AERIAL. 9-12V. Size: 2¼" x 1½" x 3". Two versions.

#### 1. STANDARD

Performance as above. £10.00\* Ex stock.

#### 2. AUTO

Same performance as above with a change over relay r.f. operated by your transceiver for direct connection in your aerial co-ax. £16.93\* Ex stock.

### FREQUENCY CONVERTERS

#### SENTINEL DUAL GATE MOSFET 2 METRE CONVERTERS

N.F. 2dB. Gain 30dB. IFs 2 metres: 2-4MHz, 4-6MHz, 28-30MHz. 4 metres: 28-28.7MHz. 9-12V. 15mA. £24.73 Ex stock.

#### SENTINEL X 2 METRE CONVERTER

Same as above plus mains power supply. £28.80 Ex stock.

#### 70cm to 28-30MHz £28.80.

#### SENTINEL L.F. CONVERTER

10KHz - 2MHz IN. 28-30MHz OUT. 9-12V 5mA. £20.80 Ex stock.

#### SENTINEL TOP BAND CONVERTER

1.8-2.3MHz IN. 14-14.5MHz OUT. 9-12V 5mA. £20.80 Ex stock.

### S.E.M. IAMBIC KEYS

The ultimate auto keyer using the CURTIS custom LSICMOS chip. Tune and sidetone Switching. £30.00 Ex stock. Twin paddle touch key. £12.50

### S.E.M. EUROPA C 2 METRE TRANSCEIVER

100W. Tx. 2dB NF Rx. £126.50.

### 12 MONTHS COMPLETE GUARANTEE

Prices include VAT and delivery. C.W.O. or phone your credit card number for same day service.

\* means Belling Lee sockets, add £1.90 for SO239s or BNC sockets. Ring or write for more information. Place orders or request information on our Ansaphone at cheap rate times.



**FOR QUALITY CRYSTALS — AT COMPETITIVE PRICES. POPULAR FREQUENCIES IN STOCK — MADE TO ORDER 10kHz to 225MHz. RB15 Pocketfone crystals now in stock.**

2 METRE STOCK CRYSTALS. Price £1.83 for one crystal. £1.74/crystal when two or more purchased.

	HC6/U	HC6/U	HC25/U	HC25/U	HC25/U	HC6 & 25/U
	30pF TX	30pF TX	30pF and 40pF TX	20pF and 30pF RX	25pF and 20pF TX	SR RX
R0	4.0277	8.0555	12.0833	14.9888	18.1250	44.9666
R1	4.0284	8.0569	12.0854	14.9916	18.1281	44.9750
R2	4.0291	8.0583	12.0875	14.9944	18.1312	44.9833
R3	4.0298	8.0597	12.0895	14.9972	18.1343	44.9916
R4	4.0305	8.0611	12.0916	15.0000	18.1375	45.0000
R5	4.0312	8.0625	12.0937	15.0027	18.1406	44.0083
R6	4.0319	8.0638	12.0958	15.0055	18.1437	45.0166
R7	4.0326	8.0652	12.0979	15.0083	18.1468	45.0250
S8	—	—	12.1000	14.9444	18.1500	44.8333*
S9	—	—	12.1020	14.9472	18.1531	44.8416*
S10	—	—	12.1041	14.9500	18.1562	44.8500*
S11	—	—	12.1062	14.9527	18.1593	44.8583*
S12	—	—	12.1083	14.9555	18.1625	44.8666*
S13	—	—	12.1104	14.9583	18.1656	44.8750*
S14	—	—	12.1125	14.9611	18.1687	44.8833*
S15	—	—	12.1145	14.9638	18.1718	44.8916*
S16	—	—	12.1167	14.9667	18.1750	44.9000*
S17	—	—	12.1187	14.9694	18.1781	44.9083*
S18	—	—	12.1208	14.9722	18.1812	44.9166*
S19	—	—	12.1229	14.9750	18.1843	44.9250*
S20	4.0416	8.0833	12.1250	14.9777	18.1875	44.9333
S21	4.0423	8.0847	12.1270	14.9805	18.1906	44.9416
S22	4.0430	8.0861	12.1291	14.9833	18.1937	44.9500
S23	4.0437	8.0875	12.1312	14.9861	18.1968	44.9583

Also in stock: R0 to R7 and S8 to S23 for following: Belcom FS1007, FDK TM56, Multi 11 Quartz 16 and Multi 7, Icom IC2F, 21, 22A and 215, Trio Kenwood 2200, 7200. Uniden 2030 and Yaesu FT2FB, FT2 Auto, FT224, FT223 and FT202

Also in stock 4 and 8MHz TX in HC6/U for 145.8MHz. Icom crystals TX for 145.6MHz (RRO). 44MHz RX crystals in HC6 for 145.8 and 145 (RRO). All at above price.

4 METRE CRYSTALS for 70.26MHz in HC6/U at £2.25. TX 8.78250MHz. RX 6.7466 or 29.78MHz in stock.

70cm CRYSTALS in stock 8.0222 and 12.0333 in HC6 £1.85. Pye Pocketfone PF1, PF2, PF70 and Wood and Douglas £4.50 a pair or TX £2.25, RX £2.50, SU8(433.2) RBO, RB2, RB4, RB6, RB10, RB11, RB13, RB14 and RB15.

CONVERTER CRYSTALS in HC18/U at £2.85. In stock 38.666, 42.000, 70.000, 96.000, 101.000, 101.500, 105.666 and 116.000MHz.

tone BURST AND I.F. CRYSTALS in HC18/U at £2.25 in stock. 7.168MHz for 1750kHz and 10.245MHz for 10.7MHz IF's.

FREQUENCY STANDARDS in stock £2.75, HC6 200kHz, 455kHz, 1000kHz, 5.000MHz and 10.000MHz. HC13 100kHz, HC18 1000kHz, 7.000MHz, 10.700MHz, 48.000MHz and 100.000MHz.

We shall be as usual exhibiting at the GRANBY HALLS LEICESTER this year from 23 to 25 October. As a result we shall be closed from 17 to 24 October. Any inconvenience to customers is regretted.

**MADE TO ORDER CRYSTALS SINGLE UNIT PRICING**

	Price Group	Adjustment Tolerance ppm	Frequency Ranges	Price and Delivery	
				A	B
Fundamentals	1	200 (total)	10 to 19.999kHz	—	£23.00
	2	200 (total)	20 to 29.999kHz	—	£16.50
	3	200 (total)	30 to 99.999kHz	—	£10.50
	4	200 (total)	100 to 999.999kHz	—	£6.00
	5	50	1.00 to 1.499MHz	£9.00	£6.00
	6	10	1.50 to 1.999MHz	£4.75	£4.20
	7	10	2.00 to 2.599MHz	£4.75	£4.00
	8	10	2.60 to 3.999MHz	£4.55	£3.70
	9	10	4.00 to 20.999MHz	£4.55	£3.60
	10	10	21.00 to 24.000MHz	£6.00	£5.40
3rd OVT	11	10	21.00 to 59.999MHz	£4.55	£3.60
5th OVT	12	10	60.00 to 99.999MHz	£5.00	£4.00
5th, 7th & 9th OVT	13	10	100.00 to 124.999MHz	£6.15	£5.20
	14	20	125.00 to 149.999MHz	—	£6.00
	15	20	150.00 to 225.000MHz	—	£7.50

Unless otherwise requested fundamentals will be supplied with 30pF load capacity and overtones for series resonance operation.

HOLDERS — Please specify when ordering — 10 to 200kHz HC13/U, 170kHz to 170MHz HC6 or HC33/U, 4 to 225MHz, HC18 and HC25.

DELIVERY Column A 3 to 4 weeks. Column B 6 to 8 weeks.

DISCOUNTS. 5% mixed frequency discount for 5 or more crystals at B delivery. Price on application for 10 or more crystals to same frequency specification. Special rates for bulk purchase schemes including FREE supply of crystals used in UK repeaters.

EMERGENCY SERVICE SURCHARGES (to be added to A delivery prices). 4 working days £12. 6 working days £7. 8 working days £5. 13 working days £3 (maximum of 5 crystals on 4 day delivery).

CRYSTAL SOCKETS HC6/U and HC25/U 16p. MINIMUM ORDER CHARGE £1.50.

TERMS. Cash with order, cheques and postal orders payable to QSL Ltd. All prices include postage to UK and Irish addresses. Please note Southern Irish cheques and postal orders are no longer acceptable. Please send bank draft in pounds Sterling.

**PRICES ARE EX VAT. PLEASE ADD 15%**

MARKETING LTD. P.O. BOX 73 SUMMIT HOUSE, LONDON SE18 3LR

Telephone: 01-690 4889 24 hr. Ansafone: Erith (03224) 30830

Telex: 912881 CWUKTX-G (Attention QUARTSLAB). Cables: QUARTSLAB LONDON SE18.



**JUST PUBLISHED**

**amateur radio**

Gordon Stokes and Peter Bubb

All the background information you need to pass the Radio Amateurs' Examination and gain an Amateur Radio Licence for receiving and transmitting signals.

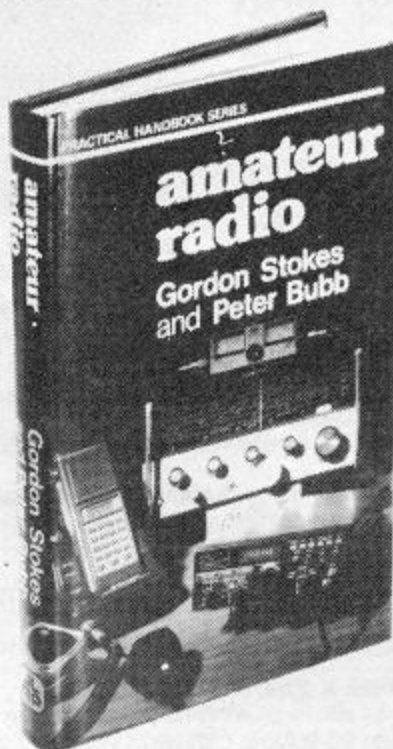

Comprehensive coverage of semiconductors, modulation, receivers, transmitters, antennas, transmission lines, HF and VHF signals and measurement of voltage and frequency, with an introduction to operating procedures and practices and safety factors.

Fully illustrated with drawings and photographs.

From leading bookshops

£8.95



**LUTTERWORTH PRESS**

Luke House, Farnham Road, Guildford, Surrey

**J. BIRKETT Radio Component Suppliers**

25 THE STRAIT · LINCOLN · LN2 1JF · TELEPHONE 20767

- CRYSTAL FILTERS 10.7MHz B.W. + 7.5kHz @ £5 each.
- POLYCARBONATE CAPACITORS .015uf 250 Volt @ 25p doz.
- VHF-UHF TAPE AERIALS Type 1. 14" long @ 15p, Type 2. 21 3/4" @ 20p.
- LOW PROFILE PCB MINIATURE 12 VOLT RELAY SPCO For Aerial Switching @ 60p.
- RE-CHARGEABLE BATTERIES 90DKO 6 Volt by Varta @ 80p.
- 1024X4 CMOS RAM TYPE 6514 with data @ £1.60.
- SILICONEX 2 CHANNEL HIGH SPEED DRIVER SPST J FET SWITCHES Type DG182A with data @ £1.15.
- CRYSTAL FILTERS SE1 QC1112V 1.4MHz BW 3.2kHz, SE1 QC1112Z 1.4MHz BW 3.2kHz, SE1 QC1512Q 1.4MHz BW 10kHz, Filtech ARA1007 1.55MHz. All Filters @ £5.
- CAMBION R.F. CHOKES 10U.H. 800mA @ 15p, 3.3MH 125mA @ 20p, 100MH 25mA @ 30p.
- VARIABLE CAPACITORS Direct Drive 5pf @ 75p, 10+ 10+ 10pf @ 75p, 250+ 250pf (500pf) @ 85p, with Slow Motion Drive 250+ 250+ 20+ 20+ 20pf @ 75p.
- CRYSTALS TO5 Can 10MHz @ £2.30, 10X Type 5MHz @ 50p.
- TRW UHF POWER TRANSISTORS 1200MHz 12 Volt, 2 Watt min., with data @ £2.50.
- VHF FETS J304 @ 30p, BF 256C @ 4 for 75p, MFE 131 @ 30p.
- X BAND GUNN DIODES with data @ £1.65.
- J BAND GUNN DIODES @ £1.65.
- MULLARD UHF MODULE BGY 21, 420-470MHz, 12 Volt, 1.2 Watt out, with data @ £12.
- MULLARD UHF MODULE BGY 22C 380-512MHz, 13 Volt, 2.5 Watt, with data @ £12.50.
- MULLARD UHF MODULE BGY 23 420-480MHz, 12 Volt, 7 Watt, with data @ £15.
- MULLARD HF-VHF POWER TRANSISTOR 26 to 70MHz, 40 Watt FM-SSB, 28 Volt 587 BLY, with data @ £3.
- MULLARD VHF POWER TRANSISTOR BLY55, 175MHz, 4 Watt, 13 Volt, with data @ £2.50.
- MULLARD VHF POWER TRANSISTOR BLY97, 175 MHz, 4 Watt, 24 Volt, with data @ £3.
- MULLARD SSB-FM TRANSISTOR 40 Watt, 570BLY, 28 Volt, with data @ £8.30.
- MULLARD UHF TRANSISTOR BFR64, 470MHz, 12-24 Volt, 4 Watt, with data @ £4.
- MINIATURE AIRSPACED TRIMMERS 50pf @ 15p, VHF TETFER TRIMMER 10pf @ 18p.
- EDDYSTONE TRANSMITTING VARIABLE 30+ 30pf (60pf) @ £2.30.
- MULLARD SUB-MINIATURE DISCS 1000pf 63v.w. @ 25p doz.
- MINIATURE VARIABLE 25+ 25pf @ 75p.
- SUB-MINIATURE EMCAP DISCS .01uf 100v.w. @ 5p each.
- CERAMIC TRIMMERS 2.5 to 6pf, 3 to 10pf, 4.7 to 20pf, 7 to 35pf, 10 to 40pf, 10 to 60pf, all @ 15p each.
- FILM TRIMMERS 4pf, 10pf, 20pf, 60pf, all @ 15p each.
- PLASTIC TRANSISTORS BC 548 or BC 549 @ 6 for 50p.
- LOCKFIT TRANSISTORS BC 147, BC 148, BC 149, BF 194, BF 195, BF 196, BF 197, BC 157, BC 158, BC 159, BCX 32, BCX 35, BCX 36, BFX 32, all @ 15p each. 6 for 50p.
- TANTALUM BEAD CAPACITORS .1uf 35v.w., .33uf 35v.w., 2.2uf 35v.w., 4.7uf 16v.w., 4.7uf 35v.w., 10uf 10v.w., 10uf 25v.w., all @ 10p each. 15uf 25v.w., @ 15p, 22uf 25v.w. @ 25p, 33uf 10v.w. @ 25p, 47uf 10v.w. @ 30p, 100uf 20v.w. @ 40p, 330uf 3v.w. @ 20p, 470uf 6v.w. @ 20p.
- SILVER MICA CAPACITORS 13, 15, 33, 47, 82, 213, 430, 460, 560, 620, 820, 1800, 15,000pf, all at 10p each.
- ORP 62 CADMIUM SULPHIDE PHOTOCONDUCTIVE CELL @ £1.30.
- 5GHZ LOW NOISE STRIPLINE NPN TRANSISTOR with data @ £3.
- 8 DIGIT 600MHz FREQUENCY COUNTER HFC600 special price £108.

Please add 30p for post and packing. Orders over £3 post free.



# M & B RADIO

## INVERTED VEE DIPOLES

ONLY £32.00

MULTIBAND 10-11-15-20-40-80 metres

- 2 Kw handling power.
- Heavy duty stranded non-corrosive & plastic coated.
- Total length 26 metres

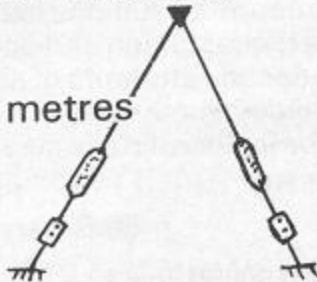

## RADIATION DETECTOR

ONLY £2.70

- Metal cased.
- Contains 3 lenses.
- Quartz fibre type.
- Only the size of a pen.

Complete with information

DETECT RADIATIONS BEFORE IT IS TOO LATE

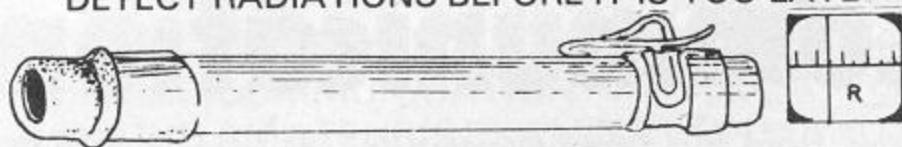

Bosch 2.5 Kw 40µF capacitor £8.00.

- Mini transformer 12 volt 250mA £1.00 p&hp inc.
  - Transformers 12-0-12, 24-0-24 500mA £3.25 VAT p&hp inc.
  - Auto wound 240-110 volt, 6.3A £9.00.
  - Transformer 15-0-15 volt, 5A £6.50.
- VAT & p&hp extra unless stated.

**M & B RADIO** 86 BISHOPSGATE STREET  
 Tel: (0532) 35649 Leeds LS1 4BB

## R. T. & I. ELECTRONICS LTD.

Ashville Old Hall, Ashville Road, London E11 4DX. Tel. 01-539 4986  
 Nearest Station: Leytonstone (Central Line)

We are MAIN DISTRIBUTORS for AVO, MEGGER, TAYLOR and SULLIVAN INSTRUMENTS

### FULLY OVERHAULED EQUIPMENT

EDDYSTONE EC10 Mk. 1. Receiver	£103.50
EDDYSTONE EC10 Mk. 2. Receiver	£126.50
HAMMARLUND Model SP600JX	£245.00
KW2000E Transceiver. As new	£327.75
KW204 Transmitter. As new	£253.00
EDDYSTONE 940 Receiver	£236.90
EDDYSTONE EA12B.S. Receiver	£236.90
DRAKE SPR4 Receiver	£405.75
TRIO JR310 Amateur B.S. Receiver	£131.10
HAMMARLUND HQ170 AMATEUR B.S. RECEIVER	£213.90
YAESU FRG-7. As New	£175.00

### NEW EQUIPMENT

TRIO R-300 Receiver	£193.89
YAESU FRG-7 Receiver	£199.00
YAESU FRG-7000 Receiver	£299.00
YAESU FRG-7700 Receiver	£309.00
MEMORY UNIT FOR FRG-7700	£83.95

AVO Digital Multimeter Model DA211	£66.12
AVO Digital Multimeter Model DA212	£86.67
AVO Digital Multimeter Model DA116	£140.53
AVO Digital Multimeter Model DA117 Auto Range	£181.12
AVO Digital Multimeter Model DA118	£231.72
Taylor Analogue Multimeter Model 131	£20.12
Taylor Analogue Multimeter Model 132	£24.72

Cases for AVO, TAYLOR & MEGGER instruments in stock. Send for Details.  
 We also repair all types of instruments. Trade and Educational enquiries invited.

SINCLAIR DM235 Digital Multimeter	£60.38
Carrying Case for DM 235	£8.86
Mains Adaptor for DM 235	£5.69
SINCLAIR PDM35 Pocket Digital Multimeter	£39.68
SINCLAIR PFM200 Pocket Digital Frequency Meter	£57.27
PARTRIDGE "JOYSTICK". New improved VFA, £29.00. JOYMATCH IIIIB, £22.55.	
LO-Z500, £28.62. JOYMATCH A.T.U. Kit, £10.50. A.T.U. Kit assembled, £12.75.	
Artificial earth and bandswitch, £10.50.	

SHURE MICROPHONES, 526, T £35.42; 444, £29.21; 401A, £14.95; 202, £13.80; 201, £13.11; 414A, £22.43; 414B, £22.43. Full details on request.

### SCOPEX OSCILLOSCOPES IN STOCK.

TMK METERS: Model TP10S, £18.05. Model 500TU-B, £33.23. Model TW20CB, £39.56. Model TP5SN, £21.27. Model 700, £68.42. Also in stock Leather Cases for above. Model 700B, £72.16. Model 3020E (Digital) £115.00. Full details on request. In present conditions we regret that all prices are subject to alteration without notice. ALL PRICES INCLUDE VAT AND CARRIAGE. Terms: C.W.O., Approved Monthly Accounts, Hire Purchase and Part Exchange. Special facilities for export.

HOURS - 9.30 am - 5.30 pm MON.-FRI. CLOSED SATURDAYS

## REG WARD (G2BSW) & CO. LTD.

South West Stockists for

YAESU - SWAN CUBIC - KDK

### YAESU PRICES

FT902DM	£799.00	FT290	£229.00
FT101ZD MkIII FM	£599.00	FT202	£109.00
FC902	£126.50	FT208R	£195.00
SP901	£28.75	NC1	£19.15
FT707	£529.00	FT480R	£359.00
FP707	£109.25	FP80	£59.00
FC707	£80.50	CPU2500R	£315.00
FL101	£142.60	FT225RD	£565.00
FT7B	£399.00	FP4	£41.40
YC7B	£67.85	FP12	£78.20
FRG7	£199.00	YH55	£9.94
FRG7700	£309.00	YE7A	£5.75
FRG7700M	£389.00	YD846	£5.75

CONTACT US FOR SPECIAL PRICES ON THE FOLLOWING  
 ★ FT200 with FP200 ★ FR101S

### SWAN CUBIC

ASTRO 102 BX	£798.00	PSU6 (for 102)	£142.00
ASTRO 150 MX	£613.00	PSU5 (for 100/150)	£135.00
100 MX	£418.00		

10% discount on above Swan Cubic prices for cash/cheque sales.

KDK FM 2025 £199.00

Ancillary equipment stocked include: Valves, Shure microphones, SEM range of products, aerials and aerial accessories, cables, rotators, plugs, sockets, etc.

Please check prices and availability before ordering. VAT included in all prices - carriage extra.

TERMS: CASH/CHEQUE WITH ORDER.  
 ACCESS/BARCLAYCARD/TRUSTCARD ACCEPTED.  
 H.P. ALSO AVAILABLE.

GEORGE STREET, AXMINSTER, DEVON EX13 5DP  
 Telephone (0297) 33163

## Give as they Gave

Thousands of men and women who served in the Royal Air Forces have given their health or even their lives in the defence of Freedom and many of them or their dependants are now in need of help. Please assist by giving all you can for an emblem during WINGS WEEK in September or please send us a donation.



To: Royal Air Forces Association, Appeals Dept.,  
 Portland Road, Malvern, Worcs. WR14 2TA

I enclose a donation of ..... for the Wings Appeal Fund.

Name.....

Address.....

Please tick if receipt is required.

**No donation is too small**

Space donated by Short Wave Magazine Limited

# Thanet Electronics

## IC-2E



The Largest Selling Amateur Transceiver in the World!

### CHECK THE FEATURES

**FULLY SYNTHESIZED** — covering 144-145.995 in 400 5kHz steps.

**POWER OUTPUT** — 1.5W with the 9V rechargeable battery pack as supplied — but lower or higher output available with the optional 6V or 12V packs.

**BNC ANTENNA OUTPUT SOCKET** — 50 ohms for connecting to another antenna or use the Rubber Duck supplied.

**SEND/BATTERY INDICATOR** — Lights during transmit, but when battery power falls below 6V it doesn't light indicating the need for a recharge.

**FREQUENCY SELECTION** — by thumbwheel switches, indicating the frequency.

**+5kHz SWITCH** — adds 5kHz to the indicated frequency.

**DUPLEX-SIMPLEX SWITCH** — gives simplex or plus 600kHz or minus 600kHz Transmit.

**HI-LOW SWITCH** — reduces power output from 1.5W to 150mW reducing battery drain.

**EXTERNAL MICROPHONE JACK** — If you do not wish to use the built-in electret condenser mic an optional microphone/speaker with PTT control can be used. Useful for pocket operation.

**EXTERNAL SPEAKER JACK** — for speaker or earphone.

This little beauty is supplied ready to go complete with nicad battery pack, charger, rubber duck.

A Full range of accessories in stock.

IC ML1	
10 Watt Mobile Booster For IC 2E	£49.00
BP5 11 Volt Battery Pack	£30.50
BP4 Empty Battery Case For 6 x AA Cells	£5.80
BP3 Standard Battery Pack	£17.70
BP2 6 Volt Pack	£22.00
BC30 Base Charger For Above	£37.00
BC25 Mains Charger As Supplied	£4.25
DC1 12 Volt Adaptor Pack	£8.40
HM9 Speaker/Microphone	£12.00
CP1 Mobile Charging Lead	£3.20
LC 1/2/3 Cases	£3.50 each

## IC-251E

£495  
incl.



## IC-451

£599  
incl.



Icom produce a perfect trio in the VHF base station range ranging from 50 Meters thru 2 Metres to 70 Cms. Unfortunately you are not able to benefit from the 5M product in this country, but you CAN own the 215E for your 2 Metre station and the 451E for 70cms.

Both are really well designed and engineered multi-mode transceivers capable of being operated from either the mains or a 12 volt supply. Both contain such exciting features as scan facilities, automatic selection of the correct repeater shift for the band concerned, full normal and reverse repeater operation, tuning rate selection according to the mode in use, VOX on SSB, continuous power adjustment capability on FM and 3 memory channels. Of course they are both fitted with a crystal controlled tone burst and have twin VFOs as have most of ICOMs fully synthesized transceivers. These two transceivers have now become really popular throughout the world — so why not pop a note on our ansafone for more details?

# Thanet for



# ICOM



Are you sick and tired of wallies screaming 'Eyeball Eyeball' in your sensitive, DX trained, ear? Yes? Then you need our new:

**I AM NOT A CB'er** Car sticker

A mere 30p each or 50p for two (please enclose a postage stamp with your order)

**SICK OF THE 'RUN OF THE MILL' QSL CARD?**

For a Witty, Eye-Catching, Unusual and Very Original Card  
Send S.A.E. for details to:

G3SRX & G8WCD PRODUCTIONS, AMBER HILL HOUSE, AMBER HILL, BOSTON, Lincs. PE20 3RQ

**R.A.E. \*\* TUITION \*\* R.A.E.**

Obtain the highly coveted Amateur Radio Licence. Personal tuition, specifically paced to achieve this result, is available in Georgian Bath. This is a five day course leading from basic principles, through the City & Guilds syllabus, to examination level. The classes, held on the outskirts of this beautiful City, are essentially small: so each student is able to receive the required amount of tuition. Instruction is given by G3UWJ specialist in personal tuition and co-author of 'Amateur Radio'. For more than a decade students of all ages and walks of life have benefited from these courses and are now licensed amateurs. For further details please write, enclosing a S.A.E., to:

**PETER BUBB — tuition**  
58 Greenacres, Bath, Avon, BA1 4NR.  
or telephone 0225 27467

5 day courses  
refresher courses

revision courses  
private individual tuition

introduction to electronics (non-exam course)

**PORTABLE MASTS EX-GOVERNMENT**  
32 ft. heavy duty aluminium.

**COMPRISING**

Qty  
Eight 4ft x 2in interlocking sections  
Eight galvanised guy ropes  
Four 27in steel guy securing stakes  
Base plate & various accessories  
All packed in strong marine ply carrying & storage case — in new condition. £35 each plus £10 carriage & VAT = £51.75

**WILLIAMSONS**  
Mumps Bridge, Oldham, Lancs OL1 3HG  
Telephone 061 624 5441 - 3525

**PERSONAL CALLERS WELCOME**

# New! from PJ Communications

Now, from the same Workshop which produced the highly-successful **Antenna Tune-Select** for short wave listeners — now the **VHF Antenna-Tune**. Designed especially for the two-metre band, to iron out those annoying SWR problems — without having to keep cutting your antenna feeders, the **VHF Antenna-Tune** will match virtually any two-metre transceiver to its antenna. Used with a good VSWR meter, the **VHF Antenna-Tune** could produce a marked improvement on transmit and receive. It's British built for 144—146 MHz and costs only £28.95 inc. postage and packing. SO239 sockets. Don't forget — the British-made **Antenna Tune-Select** for SWL's is still available, priced at just £27.65 inc. p&p.



To: P.J. Communications. 159a, High Street, Maldon, Essex CM9 7BS.

Name .....

Address .....

.....

Please send VHF Antenna-Tune (£28.95 enclosed)

Please send Antenna Tune-Select (£27.65 enclosed)

**RADIO AMATEUR PREFIX-COUNTRY-ZONE LIST**  
published by GEOFF WATTS  
Editor of "DX News-Sheet" since 1962

The List you have always needed, the list that gives you everything, and all on one line! For each country: —

a. its DXCC "status" e. the continent  
b. the normal prefix f. the "CQ" Zone No.  
c. the special prefixes g. the ITU Zone No.  
d. the ITU callsign block allocation

Full information on Antarctic stations, USSR Klub-stations, obsolete prefixes used during the past 10 years, and much more. The List can be kept always up-to-date because ample space has been provided for adding every new prefix, each new ITU allocation, etc. Everything arranged alphabetically and numerically in order of prefix. Ideal for Contest operators and SWL's. Tell your Club-members about it. Order an extra copy for that overseas friend. 15 pages. Price 55p (UK), overseas (air mail) \$2.00 or 5 IRCs

**GEOFF WATTS**  
62 BELMORE ROAD, NORWICH NR7 0PU, ENGLAND

**SAMSON ETM-3C C-MOS KEYS**  
1µA battery drain — Why switch off?

- Self-completing dots/dashes/spaces
- Can be used either as normal electronic keyer or as an iambic mode squeeze keyer
- 8-50 wpm
- Constant 3:1 dash-dot ratio
- 6 C-MOS ICs and 4 transistors
- Plug-in PCB
- Long battery life — typically 1µA drain when idling
- Built-in battery holder for 4 x 1.5 v. batteries (but will work over 3-10 v. range)
- PCB has both a reed relay (250 v., 0.5 amp., 25 w. max.) and a switching transistor (300 v., 30 mA., max.) — either keying method can be used
- Has the well-known fully-adjustable Samson precision twin keying lever assembly
- Operate/Tune button
- Sidetone oscillator
- Grey case 4" x 2" x 6". ETM-3C, £66.86.

**ETM-4C MEMORY KEYS:** Has ETM-3C features plus 4 memories of 22 characters each (or two of 44). Erase/Rewrite memories as needed — Send CQ's etc. by pressing button. £124.95.

**BUILT FOR DEPENDABLE MARINE AND COMMERCIAL SERVICE**  
**JUNKER PRECISION HAND KEY:** A superbly engineered straight key used for many years by professionals afloat and ashore. With this key you can't help but send good morse. Free-standing — no screwing down. Front and back contacts — fully adjustable gaps/tension. Keyclick filter. Hinged grey cover. £39.87.  
**BAUER KEYING PADDLE:** Single-paddle unit on 1 1/4" x 2" base for home-built El-bugs. Adjustable gaps/tensions. £13.85.

All prices post paid UK and include 15% VAT. Please send stamp with enquiries.

**SPACEMARK LTD.**  
Thornfield House, Delamer Road, Altrincham, Cheshire. (Tel: 061-928 8458)

**G4DSG D.P. HOBBS (NORWICH) LTD. G3HEO**  
**RADIO COMPONENT SPECIALISTS**

- YAESU FRG7 0.5-30MHz Gen. Cov. Rec. 1 MHz Segments . . . . . £199.00
- YAESU FRG7700 0.15-30MHz Gen. Cov. Rec. Clock, Timer, Digital Display . . . . . £309.00
- LOWE SRX30 0.5-30MHz Gen. Cov. Rec. 1 MHz Segments . . . . . £158.00
- LOWE SRX300 Dig. version of above . . . . . £195.00
- DAIWA SR9 2 Metre or Marine Monitor Receivers. VFO + 11 fixed positions . . . . . £46.00
- SOUND — AIR FM Marine 8 Ch. Scanning Rec. with 3 preset Ch. . . . . £85.10
- TM56B Marine Scanner Rec. with 6 Xtals . . . . . £78.99
- FDK 700EX 2 Metre FM T/Ceiver Dig. Display. Scan, Tone-Burst, etc. . . . . £189.00
- FDK 750E 2 Metre FM/SSB CW T/Ceiver Dig. Display, Tone-Burst, etc. . . . . £289.00
- R517 Airband Rec. Tuneable + 3 Fixed Xtal Positions . . . . . £49.75

Jaybeam Aerials, Test-Meters, Microphones, Microwave Modules, Converters, Transverters, Linears, Preamps, etc., for 2 Metres/70cms, Bantex Aerials, Vero Products, Capacitors, Resistors, RSGB and Bernard Books. Rechargeable Batteries, etc. Prices include VAT. All Mail Orders to Norwich. Barclay Card & Access.

**13 St. Benedict's St., Norwich. Tel. 615786**  
Open 9 a.m. — 5.50 p.m. Mon. — Sat. Closed all day Thursday.

Also Visit D.P. Hobbs Ltd., 11 King St., Luton. Telephone 20907.  
Closed all day Wednesday.

## a selection of specially recommended titles . . .

* THE RADIO AMATEUR'S HANDBOOK, 1981 (ARRL) . . . . .	soft cover £8.60
* RADIO DATA REFERENCE BOOK (RSGB) . . . . .	£4.80
* BETTER SHORT WAVE RECEPTION, by W6SAI and W2LX . . . . .	£3.00
* HINTS AND KINKS (ARRL) . . . . .	£2.85
* SOLID STATE DESIGN FOR THE RADIO AMATEUR (ARRL) . . . . .	£5.60
* GUIDE TO BROADCASTING STATIONS, new 18th Edition . . . . .	£3.40
* ANTENNA BOOK, 13th Edition (ARRL) . . . . .	£4.15
* AMATEUR RADIO QUESTIONS & ANSWERS, by Judd G2BCX . . . . .	£2.25
* RADIO FREQUENCY INTERFERENCE (ARRL) . . . . .	£2.00
* TOWER'S INTERNATIONAL TRANSISTOR SELECTOR, latest (1980) Edition . . . . .	£10.40
* SIMPLE, LOW-COST WIRE ANTENNAS, by W. Orr W6SA1 . . . . .	£4.45
* A GUIDE TO AMATEUR RADIO, 18th Edition (RSGB) . . . . .	£2.95
* TEST EQUIPMENT FOR THE RADIO AMATEUR (RSGB) . . . . .	£5.75
* AMATEUR RADIO TECHNIQUES, 7th Edition (RSGB) . . . . .	£6.00
* AMATEUR RADIO OPERATING MANUAL (RSGB) . . . . .	£4.95
* VHF/UHF MANUAL, 3rd Edition (RSGB) . . . . .	£8.50
* RADIO COMMUNICATION HANDBOOK, Vol. I (5th Ed.) RSGB . . . . .	£10.15
* RADIO COMMUNICATION HANDBOOK, Vol. II (5th Ed.) RSGB . . . . .	£9.00
* RADIO AMATEUR'S EXAMINATION MANUAL, 8th Ed. (new syllabus) RSGB . . . . .	£2.70

*(all prices include post/packing)*

### Available from SHORT WAVE MAGAZINE

Publications Dept.,

34 HIGH STREET, WELWYN, HERTS. AL6 9EQ. Telephone: Welwyn 5206/7.

### CALL BOOKS

#### INTERNATIONAL:

#### RADIO AMATEUR CALL BOOKS (1981)

Foreign ("DX") Listings . . . . .	£9.80
U.S. Listings . . . . .	£10.30
U.K. Callbook, 1981 Edn. (RSGB) . . . . .	£4.25

### MAPS

#### "SHORT WAVE MAGAZINE" DX ZONE MAP

(GREAT CIRCLE) in colour. Latest 9th edition . . . . . £3.35

AMATEUR RADIO MAP OF WORLD Mercator Projection —  
Much DX Information — in colour. Latest 14th edition . . £1.10

RADIO AMATEUR MAP OF THE U.S.A. AND NORTH  
AMERICA State Boundaries and Prefixes, size 24" x 30",  
paper. Latest 7th edition . . . . . 95p

RADIO AMATEUR'S WORLD ATLAS In booklet form,  
Mercator projection, for desk use. Gives Zones and  
Prefixes. Latest 11th edition . . . . . £1.65

### LOG BOOKS

Amateur Radio Logbook . . . . .	£2.80
Receiving Station Log . . . . .	£2.60
Mobile Logbook . . . . .	£1.10

*(The above prices include postage and packing)*

*Available from:*

Publications Dept.

### Short Wave Magazine

34 High Street, Welwyn, Herts. AL6 9EQ

Tel: Welwyn (043871) 5206/7

(Counter Service, 9.30-5.00 Mon. to Fri.)

(Giro A/c No. 547 6151)

# BETTER SHORT WAVE RECEPTION

by William I. Orr W6SAI and Stuart D. Cowan W2LX

4th Edition

In the latest edition of this excellent work for all those who own (or intend to own) a radio receiver, these two well-known and respected writers have produced chapters covering: the radio spectrum and what you can actually hear world-wide; the tuning of a shortwave receiver; the business of buying a receiver, both new and secondhand; a description of the SW Rx in non-technical terms, together with receiver adjustment and alignment; DX-ing above 30 MHz; a description of the VHF receiver; building and adjusting efficient aerials; reception techniques.

Thoroughly readable and "digestible", this book is without doubt a very valuable addition to the bookshelf of any SWL.

160 pages

**£3.00** inc. post

*Order from:*

Publications Dept.

**Short Wave Magazine Ltd.**  
34 High Street, Welwyn, Herts. AL6 9EQ



# ICOM

## the amateur's professional friends

Several new products from Icom will be introduced onto the market shortly and when we recently saw the prototypes in Japan we realized just how popular they are going to be. Just to wet your appetites here are a couple of examples:—

IC-290E

**£359**  
incl.

AVAILABLE NOW!

IC-25E

**£249**  
incl.

AVAILABLE VERY SOON!



The IC-290E incorporates all the features you could want in a multimode mobile to make it easy to use when driving. A standard 600kHz repeater offset shift is built into its computer's memory but if necessary this can be altered from the front panel for unusual shifts that may be required (such as say 1.6MHz for some transvertors). There are five programmable memories and these can be used in either simplex or duplex mode. Any one of these memories can also be designated as a PRIORITY CHANNEL which can be checked once every five seconds if you wish for that private message you may be expecting. Scanning can be controlled either from the front panel or from the HM10 microphone. There are options to scan the whole band, any selected part of it, or just the memory channels. You do NOT lose the repeater shift when scanning or using either of the VFOs in simplex. Unlike many of its competitors you do have TWO VFOs which can also prove a very useful feature. Further improvements include a brighter frequency readout, an LED bar-type S-Meter and power output meter and the ideal tuning rates of 25kHz per step on FM and 100Hz per step on SSB. Both these rates can be changed to 1kHz steps by use of the TS button on the front panel. For repeater operation both + and - shifts are available and it is possible to listen on the repeater input channel merely by pressing a button. Internal controls allow you to vary scan speed, scan delay times, etc. Semi break-in CW, and CW sidetone are also available.

Put all these features into an attractive case, add the world wide renowned ICOM quality and performance, and you must see that this is the choice for you. And just as an extra, remember that you get a full two years' warranty if you purchase your transceiver direct from THANET or one of our agents listed in this advertisement.

Again ICOM seem to have got everything right with its new 25W FM mobile. It is one of the smallest around and yet is packed with features which make it really handy to use while still maintaining the very high quality expected in ICOM transceivers.

Like its bigger multimode brother, the IC-25 has TWO VFOs, FIVE MEMORIES (which can be used in either simplex or duplex mode) a PRIORITY CHANNEL (which can be any one of the frequencies stored in the memories) full DUPLEX and REVERSE DUPLEX operation and a crystal controlled tone burst. Again the display is brighter and there is an LED Bar-type S-Meter and relative power output meter. The choice of frequency steps is 25kHz and 5kHz. Like the IC-290 multi-scanning functions are available either from the front panel or remotely using the HM-10 scanning microphone.

Again we feel that this beautifully designed and constructed piece of equipment is bound to "sell like hot cakes" — and again remember that if you buy one directly from Thanet you will get a full two years' warranty and any work will be carried out in our excellently equipped workshop. One of our engineers has been out to ICOM in Japan for a two week course to learn the "tricks of the trade".

What about other new products? — well you may well ask but we won't be giving too much away just yet. But how about a 70cm version of the IC-2E and a fully automatic antenna tuner to start off with?

**Buy direct from us and get two years warranty on all equipment**

**Thanet for**  **ICOM**

143 RECVLVER RD., BELTINGE, HERNE BAY, KENT. Tel: 02273/63859

# PROFESSIONAL EQUIPMENT FOR THE AMATEUR



IC-720A

**£849**  
incl.

IC-2KL

**£799**  
incl.

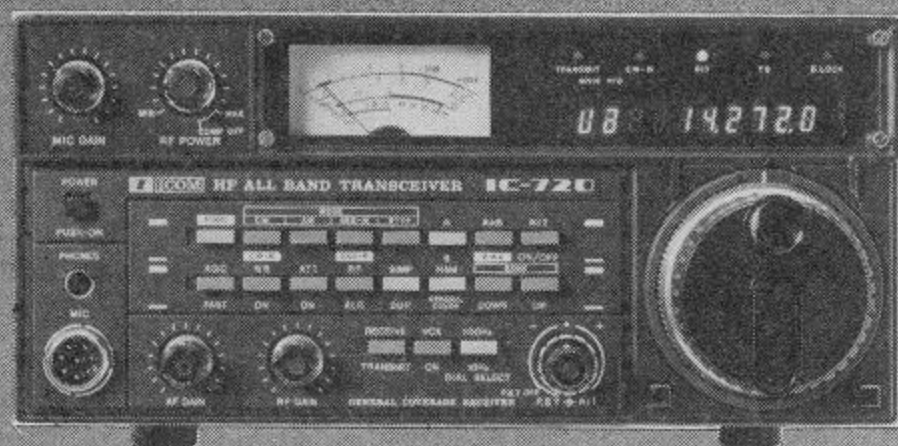

The main problem that the amateur of today has to deal with is deciding just which rig out of the many excellent products available he is going to choose. Technology is advancing at such a rapid rate and getting so sophisticated that many cannot hope to keep up! Perhaps one way of dealing with the problem is to look at just what each model offers in its basic form without having to lay out even more hard earned cash on "extras". The IC-720A scores very highly when looked at in this light. How many of its competitors have two VFOs as standard, or a memory which can be recalled, even when on a different band to the one in use, and result in instant retuning AND BANDCHANGING of the transceiver? How many include a really excellent general coverage receiver covering all the way from 100kHz to 30MHz (with provision to transmit there also if you have the correct licence)? How many need no tuning or loading whatsoever and take great care of your PA, should you have a rotten antenna, by cutting the power back to the a safe level? How many have an automatic RIT which cancels itself when then main tuning dial is moved? How many will run full power out for long periods without getting hot enough to boil an egg? How many have band data output to automatically change bands on a solid state linear AND an automatic antenna tuner unit, when you are able to add these to your station?

Well you will have to do quite a bit of hunting through the pages of this magazine to find anything to approach the IC-720-A. It may be just a little more expensive than some of the others — but when you remember just how good it is, and of course the excellent reputation for keeping their secondhand value you will see why your choice will have to be an IC-720A!

To compliment the excellent IC720A HF Transceiver, ICOM have produced the IC2KL linear amplifier. It is of a similar size and matches the IC720A perfectly. It produces 500W output on SSB, CW, AM and RTTY, needing 80—100W of drive. As with the IC720A, it will operate from 1.6MHz to 30 MHz continuously at full output power, but you still need an antenna that matches! It will follow the IC720A, automatically changing bands WITH NO TUNING — the operating is done from the prime mover. This automatic facility can be overridden for use on rigs other than the IC720A, but can be added to the IC701 and the IC720. The IC2KL employs a heat pipe cooling system for the heatsink of the power transistors. This is a new technology used to transfer the heat, has a high conductance, several hundred times that of copper and a very quick response. The use of this system enables a very compact design, for which ICOM is the leader. This advanced design includes protection circuits against Mismatching, Overheating, Overcurrent, Overdriving, Over Output Power, and the PA units unbalancing. Its spurious emissions are more than 60 dB below peak power output and third order distortion more than 30 dB below each tone of a two tone test, could a valve linear ever be as good as this? The IC2KL has a matching power supply the IC2KLPS delivering 40vDC at 25A continuous for 10 minutes maximum.

# Thanet for ICOM

**AGENTS (PHONE FIRST — All evenings and weekends only, except Barnsley and Burnley)**  
 Scotland Jack GM8GEC (031-665-2420) Midlands Tony G8AVH (021-329 2305)  
 Wales Tony GW3FKO (0874 2772) North West Gordon G3LEQ (Knutsford (0565) 4040)  
 Burnley (0282 38481)



# TWO YEARS WARRANTY ON ALL EQUIPMENT

IC-730

**£574**  
incl.



ICOM's answer to your HF mobile problems — the IC730. This new 80m—10m, 8 band transceiver offers 100W output on SSB, AM and CW. Outstanding receiver performance is achieved by an up-conversion system using a high IF of 39MHz offering excellent image and IF interference rejection, high sensitivity and above all, wide dynamic range. Built in Pass Band Shift allows you to continuously adjust the centre frequency of the IF pass band, virtually eliminating close channel interference. Dual VFO's with 10Hz, 100Hz, and 1KHz steps allows effortless tuning and what's more a memory is provided for one channel per band. Further convenience circuits are provided such as Noise Blanker, Vox, CW Monitor, APC and SWR Detector to name a few. Provided the IC730 is kept connected to its supply its CPU will remember your instructions — even when turned off! Built in fan keeps the finals cool and remember there is no tuning up to be done. A built-in Speech Processor boosts talk power on transmit and a switchable RF Pre-Amp is a boon on today's crowded bands. Full metering, WWV reception and connections for transverter and linear control almost completes the IC730's impressive facilities. Use this rig as a high class mobile or with a suitable 13v psu as your main base station. Give us a ring and ask for a full spec to be sent to you.

IC-202S

**£169**  
incl.

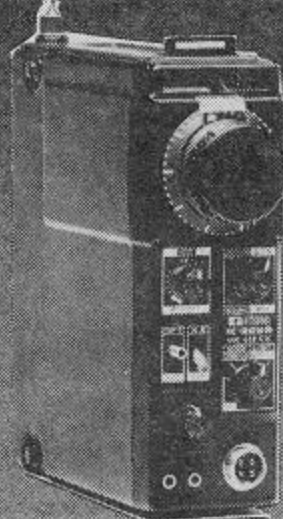

The IC-202S is a very well designed 2m SSB portable. It offers: 3W pep output on USB, LSB and CW, Large Battery capacity (HP11 type) or Nicads if you wish; A special VXO circuit to provide smooth tuning and crystal stability needed for SSB operation on 2m; Each of the four 200k Hz band positions allows operation anywhere in 2m (Supplied with 144.144.2 and 144.2-144.4). Top of the band Oscar xtals available for "cross-pond working"; It has a DC socket and SO239 sockets for mobile or base station working, barefoot or as a prime mover; Mobile mounting brackets, Nicad packs, chargers, cases all available options. You must agree, a very versatile well proved rig. The 70cm twin of the 202S having very similar features, covering the frequency range of 432-435.2 MHz. Their versatility is well worth an enquiry.

## IC-260

WE MAY STILL HAVE A FEW OF THESE AVAILABLE AT A VERY SPECIAL PRICE — CALL US FOR DETAILS

IC-24G

**£169**  
incl.



The famous IC240 has been improved, given a face lift, and renamed the IC24G. Many thousands of 240s are in use, and its popularity is due in part to simplicity of operation, high receiver sensitivity and superb audio on TX and RX. The new IC24G has these and other features: Full 80 channels (at 25KHz spacing) are available and readout is by channel number — selected by easy to operate press button thumbwheel switches. This readout can clearly be seen in the brightest of sunlight. Duplex and reverse duplex is provided along with a crystal controlled tone call Hi-10w and lo-1w RF output is available, along with a 12½ KHz upshift, should the new channel spacing be necessary. The old IC240 proved to be the most reliable rig we have ever sold — the IC24G, because it is so similar, looks like following the same pattern. Remember, for mobile use a rig MUST be easy to operate to be safe. Send for technical details.

ASK ABOUT  
TONO OR THE MANY  
OTHER PRODUCTS  
IN STOCK

# Thanet Electronics



143 RECVLVER RD., BELTINGE, HERNE BAY, KENT. Tel: 02273/63859

# Technical Books and Manuals

(ENGLISH AND AMERICAN)

## AERIAL INFORMATION

Antenna Handbook (Orr and Cowan) . . . . .	£4.10
Practical Aerial Handbook, 2nd Edition (King) . . . . .	£7.95
Beam Antenna Handbook . . . . .	£3.50
Cubical Quad Antennae, 2nd Edition . . . . .	£3.15
Simple Low Cost Wire Antennas, by Orr . . . . .	£4.45
73 Vertical Beam and Triangle Antennas (E. M. Noll) . . . . .	O/S
73 Dipole and Long-Wire Antennas (E. M. Noll) . . . . .	O/S
Antenna Book (ARRL) 13th Edition . . . . .	£4.15
The ARRL Antenna Anthology . . . . .	£2.75
Two-metre Antenna Handbook, F. C. Judd G2BCX . . . . .	£4.85

## BOOKS FOR THE BEGINNER

Amateur Radio ( <i>Lutterworth Press</i> ) . . . . .	£9.60
Questions and Answers on Amateur Radio, by F. C. Judd G2BCX . . . . .	£2.25
Transistors Q & A, new 4th Edition ( <i>Newnes</i> ) . . . . .	£2.05
Elements of Electronics, <i>Book 1</i> . . . . .	£2.50
Elements of Electronics, <i>Book 2</i> . . . . .	£2.50
Elements of Electronics, <i>Book 3</i> . . . . .	£2.50
Elements of Electronics, <i>Book 4</i> . . . . .	£3.35
Elements of Electronics, <i>Book 5</i> . . . . .	£3.35
Solid State Short Wave Receivers for Beginners (R. A. Penfold) . . . . .	£1.50
Beginners Guide to Radio (8th Edition) . . . . .	£3.70
Beginners Guide to Electronics . . . . .	£3.70
Beginners Guide to Microprocessors and Computing Course in Radio Fundamentals, ARRL . . . . .	£2.05
Guide to Amateur Radio (new 18th Edition) (RSGB) . . . . .	£3.10
Ham Radio (A Beginners Guide) by R. H. Warring . . . . .	£2.95
Morse Code for the Radio Amateur (RSGB) . . . . .	£3.95
Understanding Amateur Radio (ARRL) . . . . .	£1.20
Radio Amateur's Examination Manual, 8th Edition ( <i>new syllabus</i> ) (RSGB) . . . . .	£4.05
	£2.70

## GENERAL

An Introduction to BASIC Programming Techniques . . . . .	£2.25
How to Build your own Solid State Oscilloscope (Rayer) . . . . .	£1.75
Projects in Radio and Electronics ( <i>Newnes</i> ) . . . . .	£2.60
How to Make Walkie Talkies (Rayer) . . . . .	£1.75
How to Build Advanced Short Wave Receivers (Penfold) . . . . .	£1.40
Better Short Wave Reception, 4th Edition . . . . .	£3.00
FM & Repeaters for the Radio Amateur (ARRL) . . . . .	£3.20
Easibinder (to hold 12 copies of "Short Wave Magazine" together) <i>new A4 size</i> . . . . .	£4.65
Oscar — Amateur Radio Satellites . . . . .	£4.30
World Radio & TV Handbook 1981 Edition . . . . .	£10.55
World DX Guide . . . . .	£5.40
Guide to Broadcasting Stations (new 18th Edition) . . . . .	£3.40
Radio Stations Guide . . . . .	£2.05
Long Distance Television Reception (TV-DX) for the Enthusiast ( <i>revised edition</i> ) . . . . .	£2.25

Solid State Basics for the Radio Amateur (ARRL) . . . . .	£3.35
Counter Driver and Numeral Display Projects, Rayer . . . . .	£2.05
Electronic Test Equipment Construction (Rayer) . . . . .	£2.05
Power Supply Projects (Penfold) . . . . .	£2.05

## HANDBOOKS AND MANUALS

Radio Communication Handbook, Vol I (5th Edition) (RSGB) . . . . .	£10.15
Radio Communication Handbook, Vol II (5th Edition) (RSGB) . . . . .	£9.00
TVI Manual ( <i>2nd Edn.</i> ) (RSGB) . . . . .	£1.85
Radio and Electronic Laboratory Handbook by Scroggie-Johnstone, 1980 (9th) Ed. . . . .	£19.05
RTTY Handbook ( <i>73 Magazine</i> ) . . . . .	£3.55
Slow Scan Television Handbook ( <i>73 Magazine</i> ) . . . . .	o/s
Working with the Oscilloscope . . . . .	£4.05
The Radio Amateur's Handbook 1981 (ARRL) soft cover . . . . .	£8.60
The Radio Amateur's Handbook 1981 (ARRL) hard cover . . . . .	£11.95
Shortwave Listener's Handbook . . . . .	£4.80
Learning to Work with Integrated Circuits (ARRL) . . . . .	£1.70
Weather Satellite Handbook . . . . .	£2.90
Single Sideband for the Radio Amateur (ARRL) . . . . .	£2.95
Test Equipment for the Radio Amateur (RSGB) . . . . .	£5.75
Amateur Radio Operating Manual (RSGB) . . . . .	£4.95
Practical Electronics Handbook ( <i>Newnes</i> ), <i>new title</i> . . . . .	£4.40
Oscilloscopes — How to Use Them, How They Work ( <i>Newnes</i> ) <i>new title</i> . . . . .	£3.85

## USEFUL REFERENCE BOOKS

Solid State Design for the Radio Amateur (ARRL) . . . . .	£5.60
Foundations of Wireless and Electronics, 9th Edition (Scroggie) . . . . .	£6.15
Amateur Radio Techniques, <i>new 7th Edn</i> (RSGB) . . . . .	£6.00
U.K. Call Book 1981 (RSGB) . . . . .	£4.25
Hints and Kinks (ARRL) . . . . .	£2.85
Radio Data Reference Book (RSGB) . . . . .	£4.80
Electronics Data Book (ARRL) . . . . .	£3.15
Radio Frequency Interference (ARRL) . . . . .	£2.00
Amateur Radio Awards, RSGB . . . . .	£3.40
Electronics Pocket Book, <i>new 4th Edition</i> ( <i>Newnes</i> ) . . . . .	£6.20

## VALVE AND TRANSISTOR MANUALS

Towers' International Transistor Selector 1980 Edition (Up-Date No. 2) . . . . .	£10.40
Radio Valve and Semiconductor Data (10th Edition) . . . . .	£4.35
International Transistor Equivalents Guide, <i>new title</i> . . . . .	£3.35

## VHF PUBLICATIONS

VHF Handbook, Wm. 1 Orr . . . . .	£3.50
VHF Manual (ARRL) . . . . .	o/p
VHF/UHF Manual (RSGB) 3rd Edition . . . . .	£8.50

O/P (Out of print)

O/S (Out of stock)

THE ABOVE PRICES INCLUDE POSTAGE AND PACKING

(Terms C.W.O.)

*Many of these titles are American in origin*

*Prices are subject to alteration without notice.*

Available from

SHORT WAVE MAGAZINE

Publications Dept.

34 High Street, Welwyn, Herts. AL6 9EQ - Welwyn (043871) 5206/7

(Counter Service. 9.30-5.00 Mon. to Fri.)

(GIRO A/C No. 5476151)